

BRILUMEN DATA SHEET

PROFILES PERFIS

The profiles presented in the following pages are on a real scale.
Os perfis apresentados nas próximas páginas estão numa escala real.



TRIX



PL3

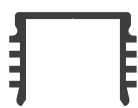

PL5



PL6



PL8



P015



P023



FP2



PN4



PN6



PN7

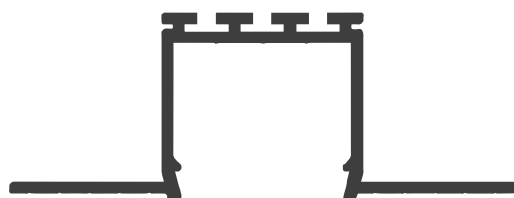

PN9

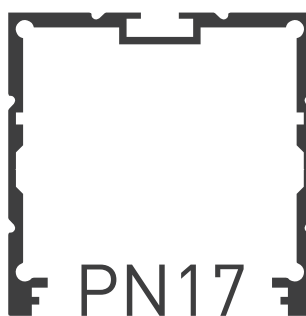

PN17

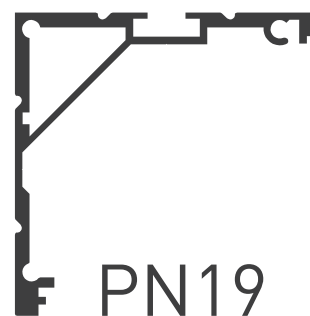

PN19

DIFFUSERS DIFUSORES

DIFFUSER - TRIX
Ref. 8080-2007
[TRIX]



DIFFUSER - C1
Ref. G8600004
[PL3 + PL8 + FP2]



DIFFUSER - C3
Ref. G8600005
[PL5 + PL6 + P015]



DIFFUSER - C4
Ref. G8600006
[PL5 + PL6]



DIFFUSER - C8
Ref. G8600013
[P023]



DIFFUSER - C10
Ref. G8600017
[PN4 + PN6+PN7]



DIFFUSER - C11
Ref. G8600018
[PN4 + PN6]



DIFFUSER - C12
Ref. G8600019
[PN4 + PN6]



DIFFUSER - C14
Ref. G8600014
[PN17]



DIFFUSER - C16
Ref. G8600023
[PN19]



DIFFUSER - C17
Ref. G8600024
[PN19]



DIFFUSER - C103
Ref. G8600031
[PN9]



BRILUMEN DATA SHEET

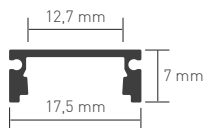

PRODUCT CODE	DESCRIPTION
8010-2002.AL	TRIX anodized aluminium profile 2000mm . Perfil de alumínio anodizado 2000mm
8010-2002.TW	TRIX textured white aluminium profile 2000mm . Perfil de alumínio branco texturado 2000mm
8010-2002.TB	TRIX textured black aluminium profile 2000mm . Perfil de alumínio preto texturado 2000mm
8080-2007	Frosted diffuser 2000mm . Difusor opalino 2000mm
8080-0004	White PVC end cap with hole . Topo em PVC branco com furo
8080-0006	Mounting bracket for TRIX profile . Grampo para perfil TRIX

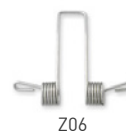
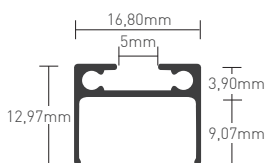

PRODUCT CODE	DESCRIPTION
G8107012	PL10 construction profile for PL - PN - PO series . Perfil de construção PL10 para series PL - PN - PO
G8106210	Z01 mounting clip for PL serie . Clip de montagem para serie PL
G8104050	Z02 mounting clip for P023 . Clip de montagem para P023
G8251001	Z06 spring-gripper . Mola de encastrar

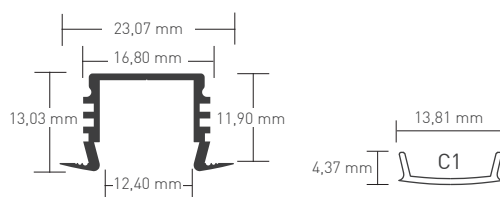

PRODUCT CODE	DESCRIPTION
G8106032	PL3 profile . Perfil
G8600004	C1 frosted diffuser . Difusor opalino
G8106135	E7 PVC end cap . Topo em PVC
G8106030	E8 PVC end cap with hole . Topo em PVC com furo
G8106120	E9 Aluminium end cap (with PL10) . Topo em alumínio (com PL10)

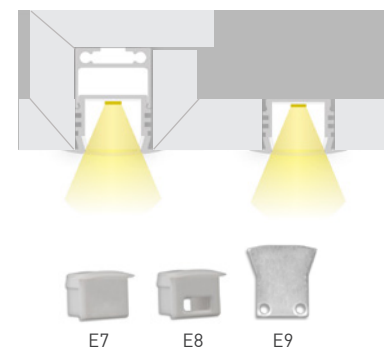

BRILUMEN DATA SHEET

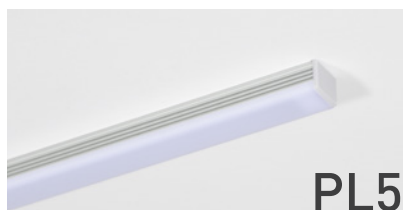

PL5

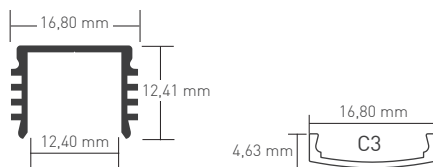

2000 mm LENGTH COMPRI.	246g WEIGHT PESO	12mm WIDTH MAX. LARGURA MAX.	PL10
----------------------------------	----------------------------	--	-------------

PRODUCT CODE	DESCRIPTION
G8105201	PL5 profile . Perfil
G8600005	C3 frosted diffuser . Difusor opalino
G8600006	C4 frosted diffuser . Difusor opalino
G8106050	E10 PVC end cap . Topo em PVC
G8106052	E11 PVC end cap with hole . Topo em PVC com furo
G8110009	E53 PVC end cap . Topo em PVC
G8110010	E54 PVC end cap with hole . Topo em PVC com furo
G8106025	E12 Aluminium end cap (with PL10) . Topo em alumínio (com PL10)

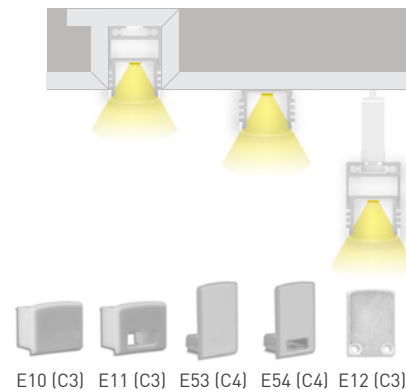

PL6

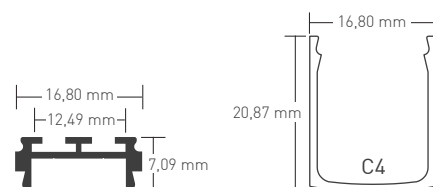

2000 mm LENGTH COMPRI.	220g WEIGHT PESO	12mm WIDTH MAX. LARGURA MAX.	PL10
----------------------------------	----------------------------	--	-------------

PRODUCT CODE	DESCRIPTION
G8106062	PL6 profile . Perfil
G8600005	C3 frosted diffuser . Difusor opalino
G8600006	C4 frosted diffuser . Difusor opalino
G8106068	E16 PVC end cap . Topo em PVC
G8106063	E17 PVC end cap with hole . Topo em PVC com furo
G8106064	E18 Aluminium end cap (with PL10) . Topo em alumínio (com PL10)

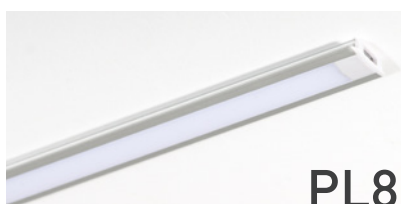
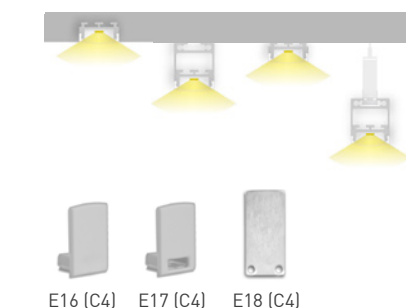

PL8

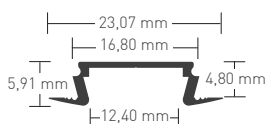

2000 mm LENGTH COMPRI.	164g WEIGHT PESO	12mm WIDTH MAX. LARGURA MAX.	PL10
----------------------------------	----------------------------	--	-------------

PRODUCT CODE	DESCRIPTION
G8106082	PL8 profile . Perfil
G8600004	C1 frosted diffuser . Difusor opalino
G8106085	E25 PVC end cap . Topo em PVC
G8106080	E26 PVC end cap with hole . Topo em PVC com furo
G8106045	E27 Aluminium end cap (with PL10) . Topo em alumínio (com PL10)

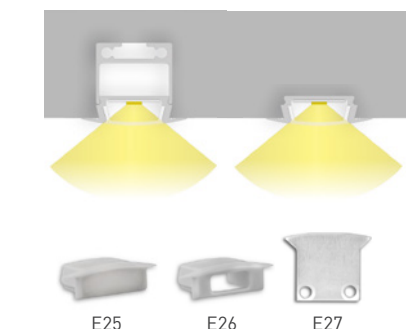

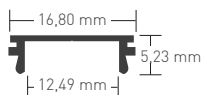

2000
mm
LENGTH
COMPRI.

132g
WEIGHT
PESO

12mm
WIDTH MAX.
LARGURA MAX.

PRODUCT CODE	DESCRIPTION
G8102062	P015 profile . Perfil
G8600005	C3 frosted diffuser . Difusor opalino
G8600006	C4 frosted diffuser . Difusor opalino
G8102060	E35 PVC end cap . Topo em PVC
G8103062	E36 PVC end cap with hole . Topo em PVC com furo

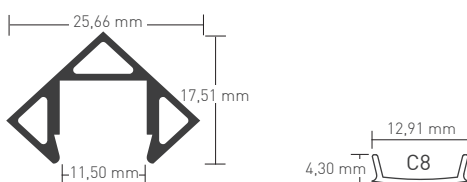
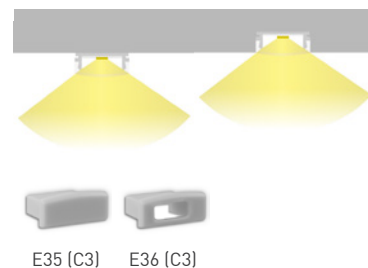

2000
mm
LENGTH
COMPRI.

460g
WEIGHT
PESO

11mm
WIDTH MAX.
LARGURA MAX.

PRODUCT CODE	DESCRIPTION
G8104052	P023 profile . Perfil
G8600013	C8 frosted diffuser . Difusor opalino
G8103050	E41 PVC end cap . Topo em PVC
G8103052	E42 PVC end cap with hole . Topo em PVC com furo

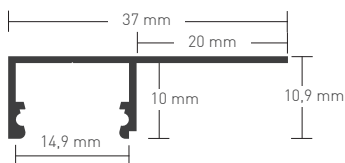
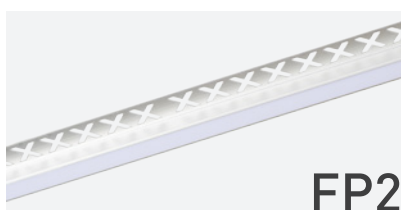
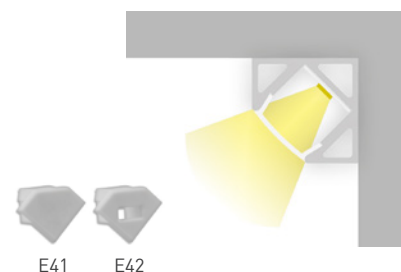

2000
mm
LENGTH
COMPRI.

326g
WEIGHT
PESO

14mm
WIDTH MAX.
LARGURA MAX.

PRODUCT CODE	DESCRIPTION
G8102034	FP2 profile . Perfil
G8600004	C1 frosted diffuser . Difusor opalino

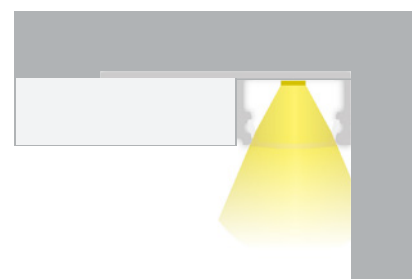



PN4

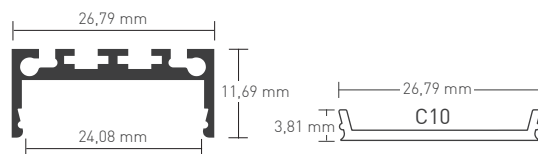

2000
mm
LENGTH
COMPRI.

460g
WEIGHT
PESO

24mm
WIDTH MAX.
LARGURA MAX.



PRODUCT CODE	DESCRIPTION
G8201012	PN4 profile . Perfil
G8600017	C10 frosted diffuser . Difusor opalino
G8600018	C11 frosted diffuser . Difusor opalino
G8600019	C12 frosted diffuser . Difusor opalino
G8201011	E43 Aluminium end cap . Topo em alumínio
G8202011	E44 Aluminium end cap . Topo em alumínio
G8203011	E45 Aluminium end cap . Topo em alumínio

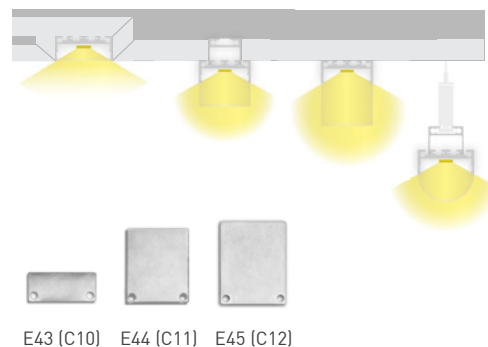

PN6

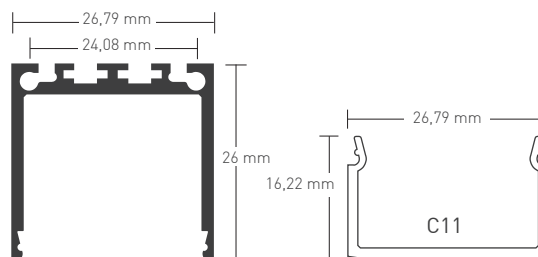

2000
mm
LENGTH
COMPRI.

730g
WEIGHT
PESO

24mm
WIDTH MAX.
LARGURA MAX.



PRODUCT CODE	DESCRIPTION
G8301012	PN6 profile . Perfil
G8600017	C10 frosted diffuser . Difusor opalino
G8600018	C11 frosted diffuser . Difusor opalino
G8600019	C12 frosted diffuser . Difusor opalino
G8301011	E47 Aluminium end cap . Topo em alumínio
G8302011	E48 Aluminium end cap . Topo em alumínio
G8303011	E49 Aluminium end cap . Topo em alumínio

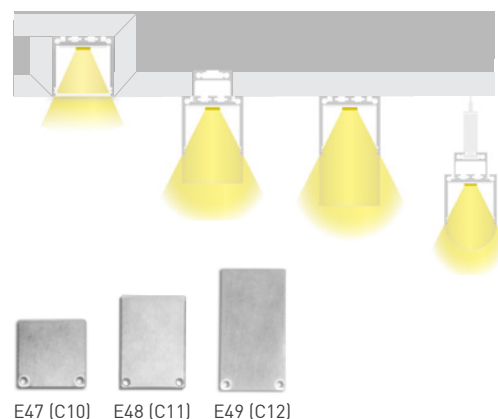

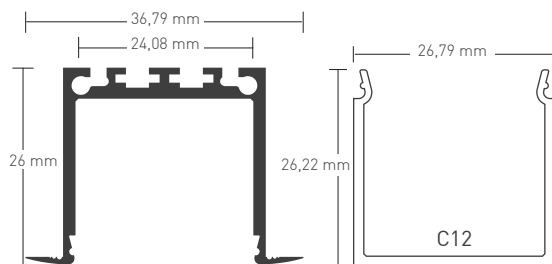

2000 mm
LENGTH
COMPRI.

758g
WEIGHT
PESO

24mm
WIDTH MAX.
LARGURA MAX.



PRODUCT CODE	DESCRIPTION
G8305012	PN7 profile . Perfil
G8600017	C10 frosted diffuser . Difusor opalino
G8600018	C11 frosted diffuser . Difusor opalino
G8600019	C12 frosted diffuser . Difusor opalino
G8301011	E47 Aluminium end cap . Topo em alumínio
G8302011	E48 Aluminium end cap . Topo em alumínio
G8303011	E49 Aluminium end cap . Topo em alumínio

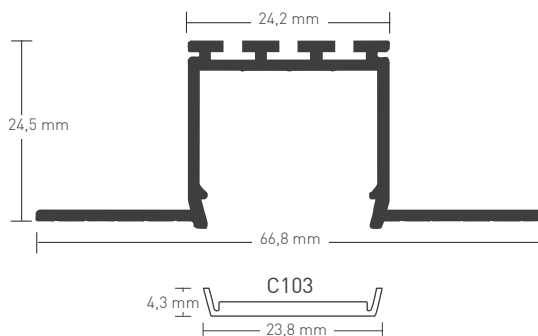
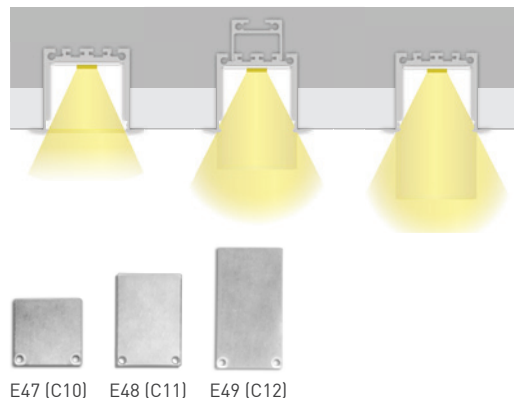

2000 mm
LENGTH
COMPRI.

776g
WEIGHT
PESO

24mm
WIDTH MAX.
LARGURA MAX.

PRODUCT CODE	DESCRIPTION
G8405001	PN9 profile . Perfil
G8600031	C103 frosted diffuser . Difusor opalino
G8405005	E105 White end cap . Topo branco

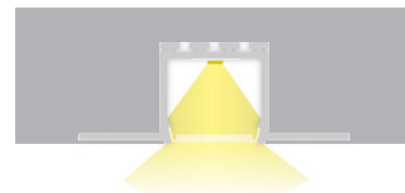

BRILUMEN DATA SHEET

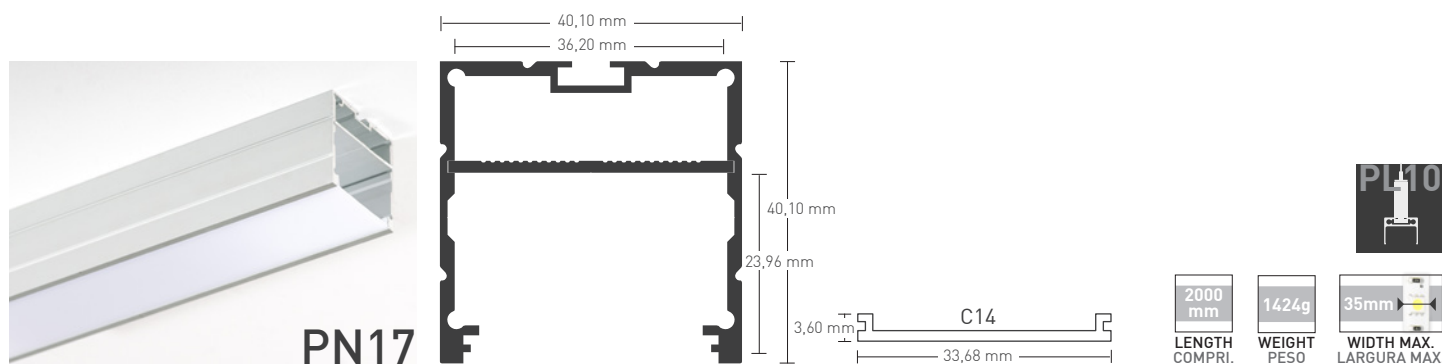

PN17

Technical drawing showing dimensions: 40,10 mm (total width), 36,20 mm (inner width), 40,10 mm (height), 23,96 mm (height to top edge), 3,60 mm (height to bottom edge), and 33,68 mm (total length of C14 diffuser).

C14

PL10

2000 mm
LENGTH COMPRI.

1424g
WEIGHT PESO

35mm
WIDTH MAX. LARGURA MAX.

PRODUCT CODE	DESCRIPTION
G8105042	PN17 profile . Perfil
G8600014	C14 frosted diffuser . Difusor opalino
G8106075	E52 Aluminium end cap . Topo em alumínio

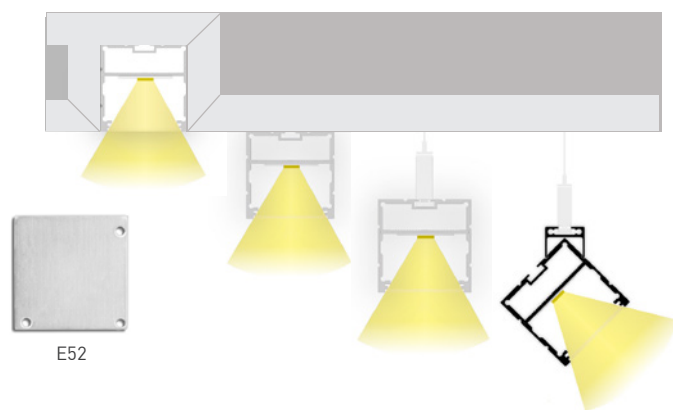
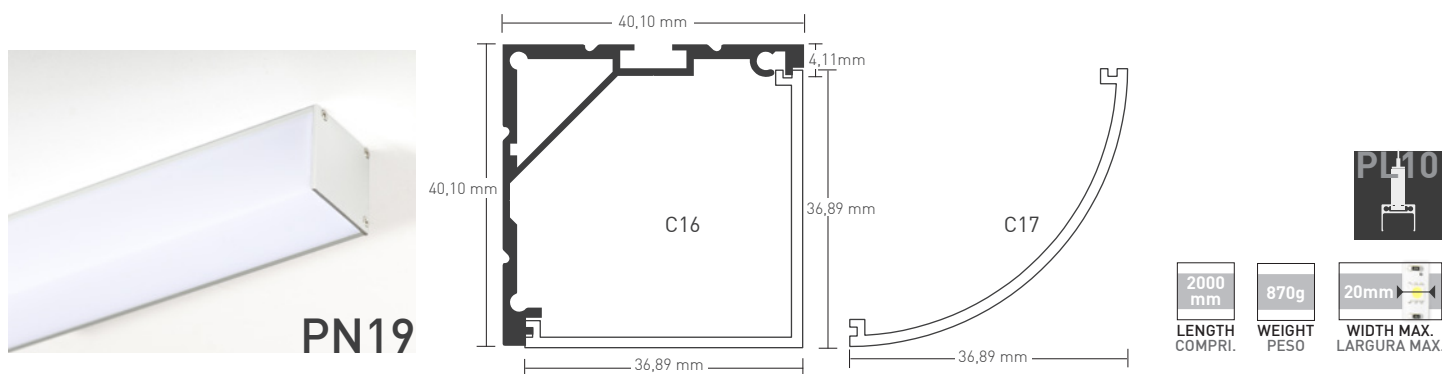
PN19

Technical drawing showing dimensions: 40,10 mm (total width), 40,10 mm (height), 36,89 mm (inner width), 4,11mm (height to top edge), and 36,89 mm (total length of C16 and C17 diffusers).

C16

C17

PL10

2000 mm
LENGTH COMPRI.

870g
WEIGHT PESO

20mm
WIDTH MAX. LARGURA MAX.

PRODUCT CODE	DESCRIPTION
G8105044	PN19 profile . Perfil
G8600023	C16 frosted diffuser . Difusor opalino
G8600024	C17 frosted difuser . Difusor opalino
G8106075	E52 Aluminium end cap . Topo em alumínio

