



Brilumen's aluminium profiles are designed and produced from top quality raw materials on modern, fully automated, precision equipment to meet the strictest European quality criteria. These profiles combine the sophisticated functionality with timeless aesthetics and fill every illuminated area with homogeneous light.

The individual system components are quickly and easily assembled using the click system and mounted in a right manner. The properties of these fracture-resistant profiles, protect LED strips from mechanical impacts, dissipate heat, and integrate perfectly into any architectural feature. The non-flammable polycarbonate profile covers reduce light to control the unified glare rating (UGR).

Due to the high availability of the product, these profiles can be supplied quickly, and they distinguish themselves through their perfect light lines and allies to the homogeneous light quality, the product quality is guaranteed at the best price-performance ratio and the intelligent product design and unique product compatibility, which allows an unlimited variety of designs.

These aluminium profiles can have customized sizes, a 4 Year Warranty and are compatible with Brilumen's LED Strips.

Os perfis de alumínio Brilumen são projetados e produzidos a partir de matérias-primas de alta qualidade, em equipamentos de precisão modernos e totalmente automatizados, de forma a corresponder aos mais rigorosos critérios de qualidade europeus. Estes perfis combinam a sofisticada funcionalidade com estética intemporal e preenchem todas as áreas iluminadas com uma luz homogênea.

Usando o sistema de clique e montados de forma correta, os componentes são rápida e facilmente montados. As propriedades específicas destes perfis resistentes às fraturas, protegem as fitas LED de impactos mecânicos, dissipam o calor e são integrados perfeitamente em qualquer sistema arquitetônico. Os difusores de polycarbonato não inflamáveis reduzem a luz para controlar o índice de encandeamto (UGR).

Graças à elevada disponibilidade do produto, estes perfis podem ser fornecidos rapidamente e destacam-se devido às suas linhas de luz perfeitas aliada a uma qualidade de luz homogênea, à qualidade garantida do produto com a melhor relação preço / desempenho e ao design inteligente e compatibilidade exclusiva do produto, que permite uma variedade ilimitada de designs. Os perfis de alumínio podem ser cortados à medida, têm 4 anos de garantia e são compatíveis com as fitas LED Brilumen.

BRILUMEN DATA SHEET

PROFILES PERFIS



PL1



PL3



PL5



PL6



PL8



P015

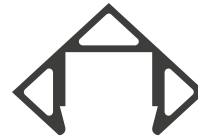

P023



PN4

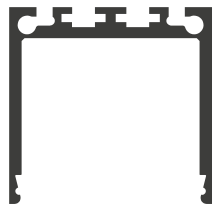

PN6

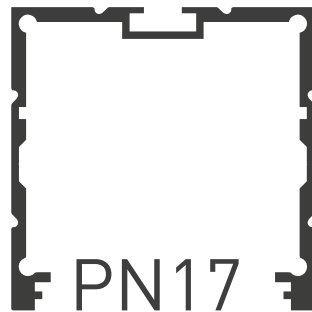

PN17

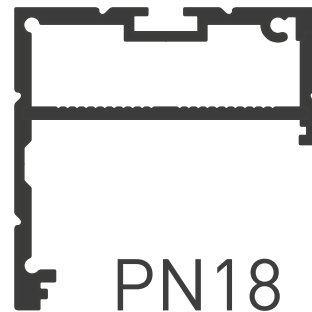

PN18

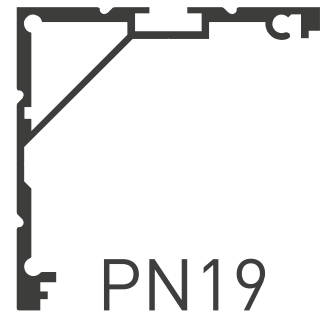

PN19

DIFFUSERS DIFUSORES

DIFFUSER - C1
Ref. G8600004
[PL1 + PL3 + PL8]



DIFFUSER - C2
Ref. G8600003
[PL1 + PL3 + PL8]



DIFFUSER - C4
Ref. G8600006
[PL5 + PL6]



DIFFUSER - C3
Ref. G8600005
[PL5 + PL6 + P015]



DIFFUSER - C5
Ref. G8600007
[PL5 + PL6 + P015]



DIFFUSER - C8
Ref. G8600013
[P023]



DIFFUSER - C9
Ref. G8600012
[P023]



DIFFUSER - C12
Ref. G8600019
[PN4 + PN6]



DIFFUSER - C10
Ref. G8600017
[PN4 + PN6]



DIFFUSER - C11
Ref. G8600018
[PN4 + PN6]



DIFFUSER - C13
Ref. G8600020
[PN4 + PN6]



DIFFUSER - C14
Ref. G8600014
[PN17]



DIFFUSER - C15
Ref. G8600022
[PN18]



DIFFUSER - C16
Ref. G8600023
[PN19]



DIFFUSER - C17
Ref. G8600024
[PN19]



BRILUMEN DATA SHEET

PVC END CAPS TOPOS EM PVC

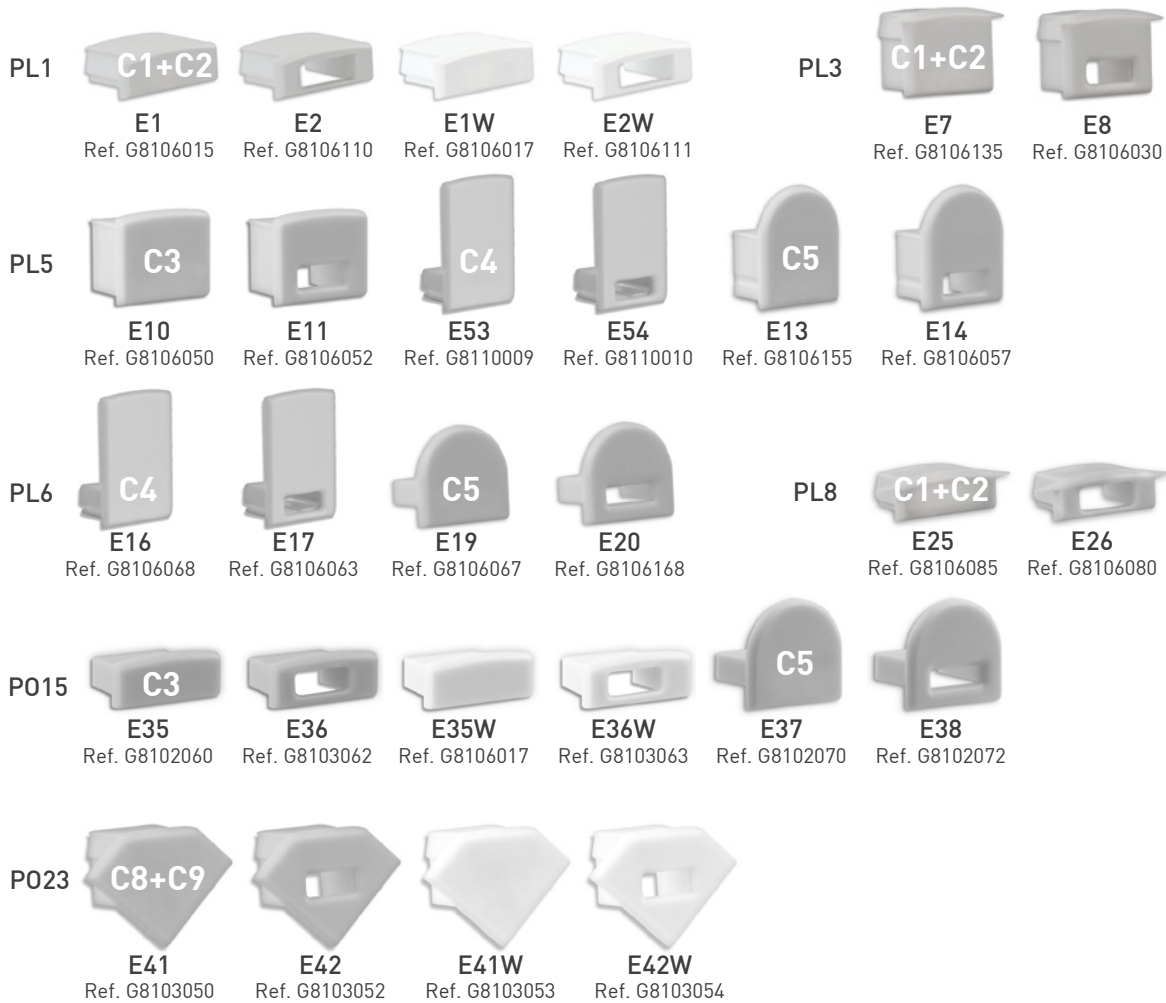

ALUMINIUM END CAPS (with PL10) TOPOS DE ALUMÍNIO (com PL10)

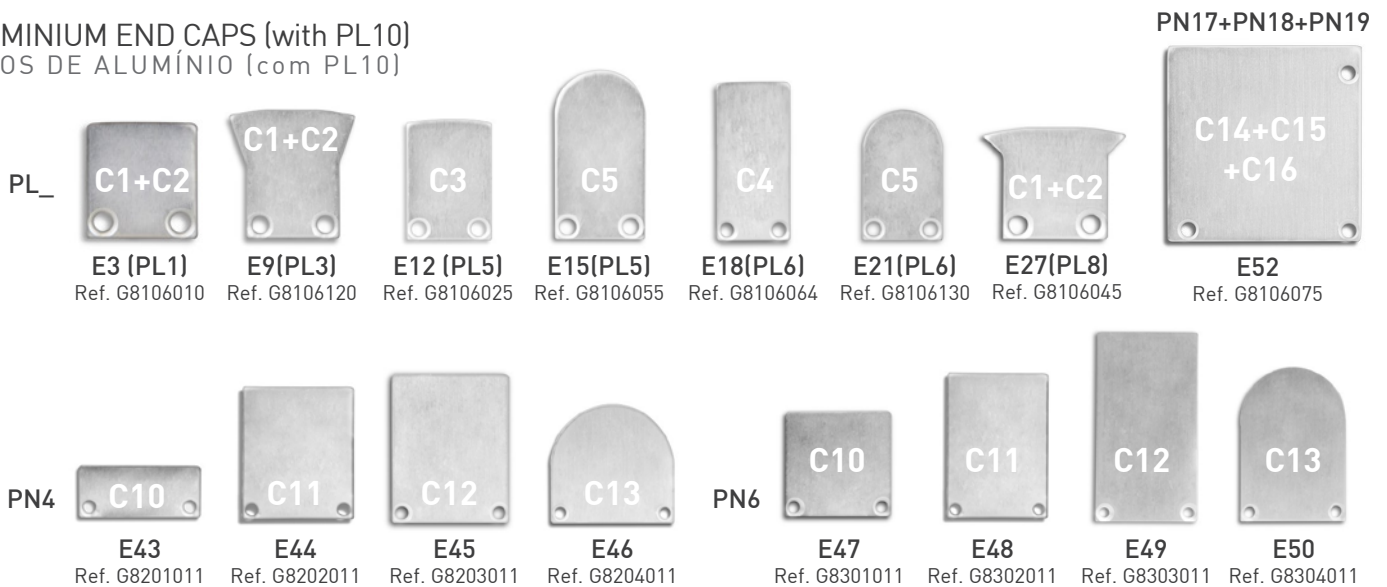



PL10

CONSTRUCTION PROFILE for universal cable
PERFIL DE CONSTRUÇÃO p/ cablagem universal

2000
mm

LENGTH
COMPRI.

262g

WEIGHT
PESO

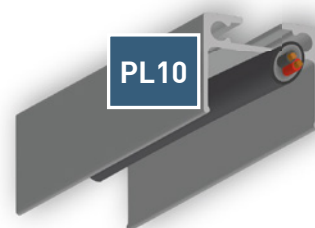
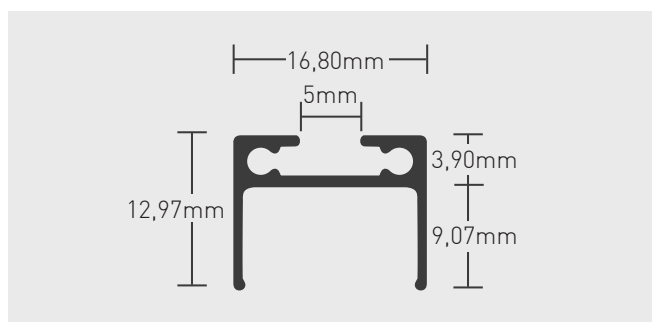

MOUNTING CLIP
CLIP DE MONTAGEM



Z01



Z02

| PRODUCT CODE | DESCRIPTION |
|--------------|--|
| G8107012 | PL10 construction profile Perfil de construção PL10 |
| G8106210 | Z01 mounting clip for PL serie Clip de montagem para serie PL |
| G8104050 | Z02 mounting clip for P023 Clip de montagem para P023 |



PN18

2000
mm

LENGTH
COMPRI.

1178g

WEIGHT
PESO

35mm

WIDTH MAX.
LARGURA MAX.

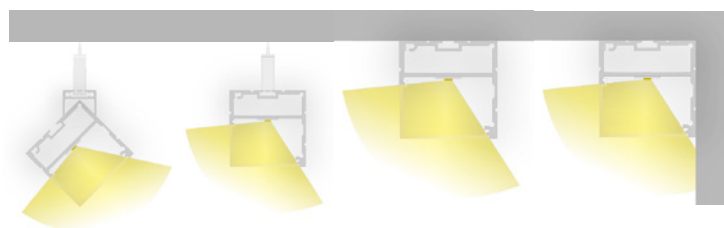
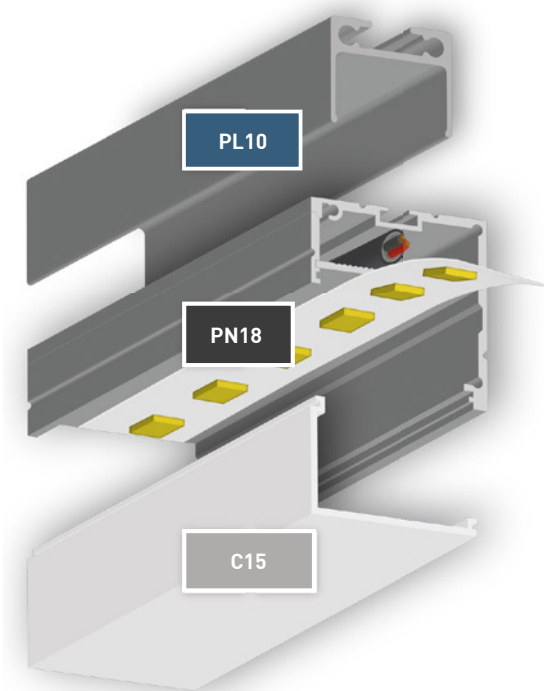
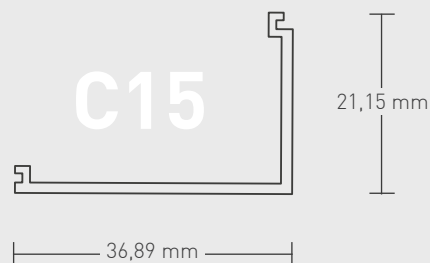
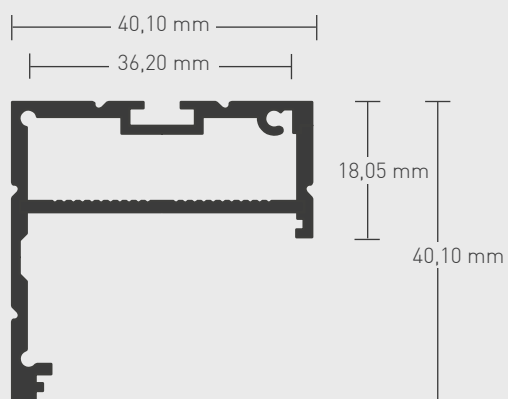

| PRODUCT CODE | DESCRIPTION |
|--------------|--|
| G8105043 | PN18 profile . Perfil PN18 |
| G8600022 | C15 frosted diffuser . Difusor opalino C15 |
| G8106075 | Aluminium end caps . Topos em alumínio |

BRILUMEN DATA SHEET



LED STRIPS COMPATIBLE WITH OUR ALUMINIUM PROFILES (SOLD SEPARATELY)
FITAS LED COMPATÍVEIS COM OS NOSSOS PERFIS DE ALUMÍNIO (VENDIDAS A PARTE)

___ Ref. 2002-138.90
PROFESSIONAL LED STRIP 300 LEDs SMD2216 . IP20 . CRI>90



___ Ref. 2002-138.80
PROFESSIONAL LED STRIP 300 LEDs SMD2216 . IP20 . CRI>80



___ Ref. 2002-123.80
PROFESSIONAL LED STRIP 60 LEDs SMD5050 . IP20 . CRI>80



___ Ref. 2002-126.80
PROFESSIONAL LED STRIP 60 LEDs SMD5050 . IP65 . CRI>80



___ Ref. 2002-1111
RGBW LED STRIP 60 LEDs SMD5050 . IP65 . CRI>70



___ Ref. 2002-128.80
PROFESSIONAL LED STRIP 120 LEDs SMD2835 . IP20 . CRI>80



___ Ref. 2002-128.90
PROFESSIONAL LED STRIP 120 LEDs SMD2835 . IP20 . CRI>90



___ Ref. 2002-129.80
PROFESSIONAL LED STRIP 60 LEDs SMD2835 . IP20 . CRI>80

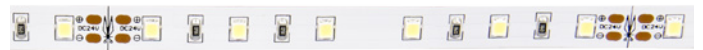

___ Ref. 2002-132.80
PROFESSIONAL LED STRIP 60 LEDs SMD2835 . IP20 . CRI>80

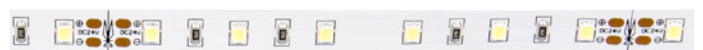

___ Ref. 2002-1112
TUNABLE WHITE LED STRIP 60 LEDs SMD5050 . IP20 . CRI>80



___ Ref. 2002-122.80
FLEX LED STRIP 60 LEDs SMD5050 . IP20 . CRI>80

