

2016 - 2017

# SHADE ART

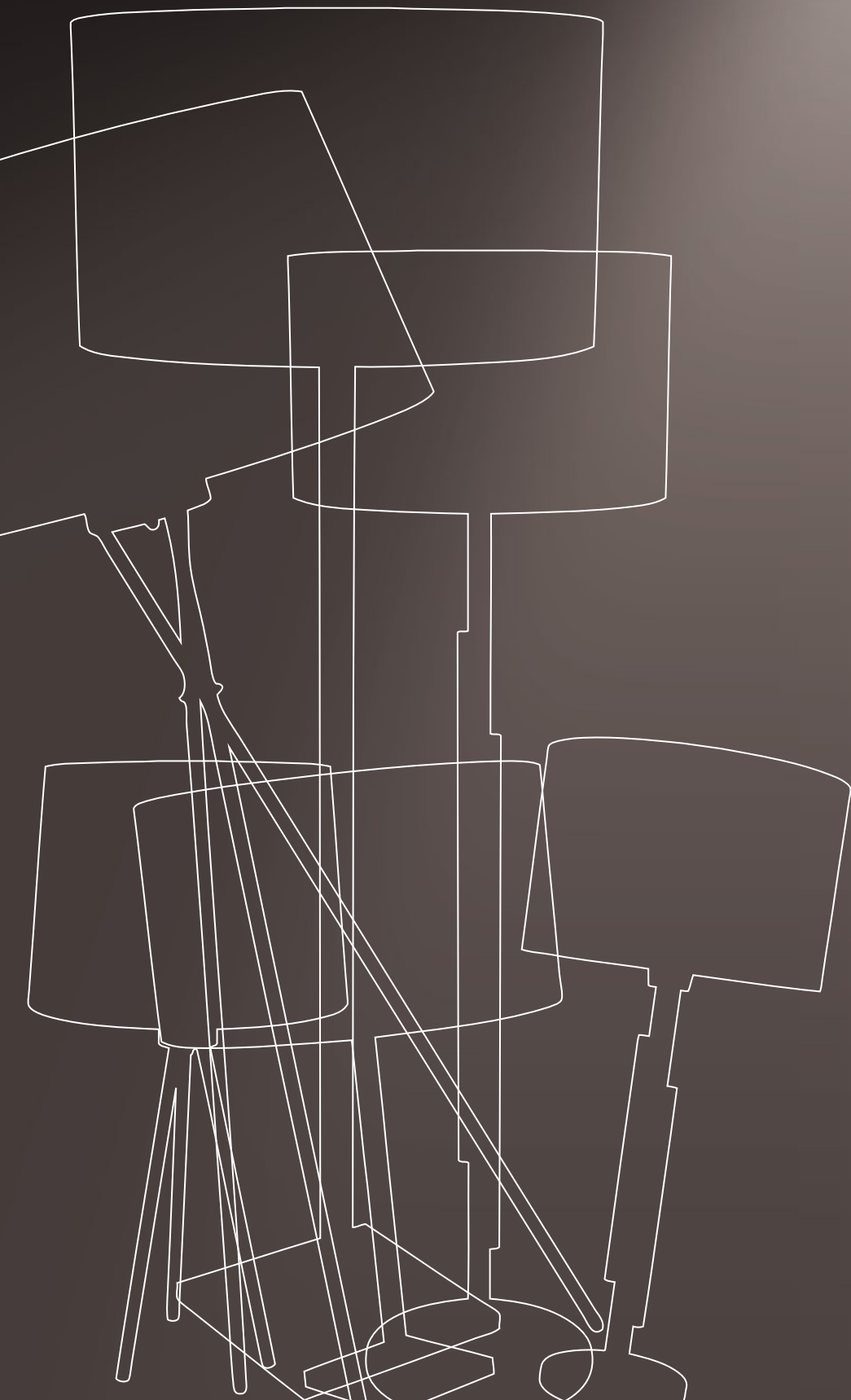

by **brilumen**



# Lighting with elegance and art

Decorate is a defiant art,  
not every colour or shape  
is suitable for all purposes,  
as each room is unique.

Life is short, and simple things are the best!  
Take a trip through our catalogue,  
amuse yourself by mixing shapes and colours.  
Create your own delightful ambience.  
Details matter.

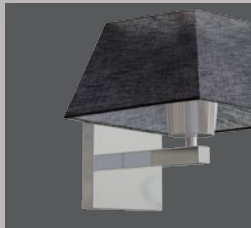
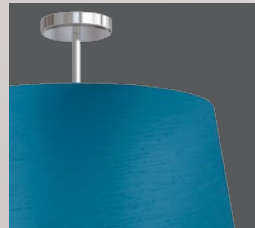
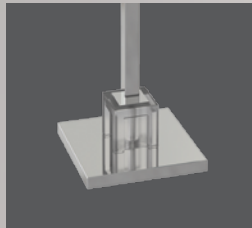
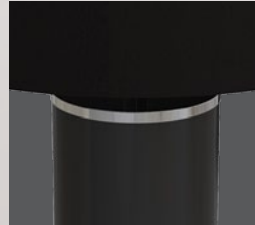
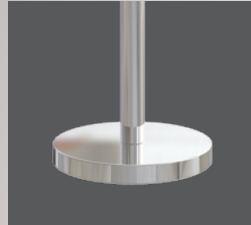

[www.brilumen.com/shades](http://www.brilumen.com/shades)

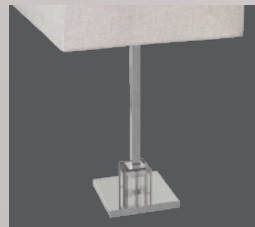
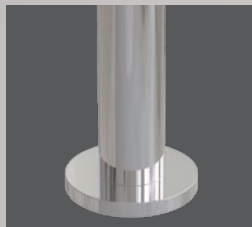
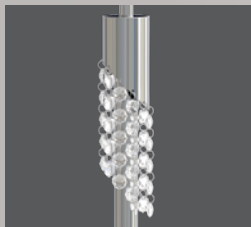
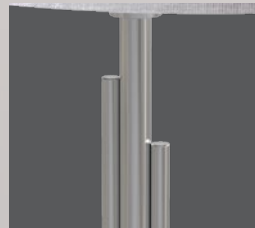

# Index

Taj Mahal	<b>9</b>	Durham	<b>27</b>
Mogao	<b>11</b>	Lamu	<b>29</b>
Stari	<b>13</b>	Tikal	<b>31</b>
Dahshur	<b>15</b>	Tsingy	<b>33</b>
Chevrons	<b>17</b>	Bases	<b>34</b>
Nikko	<b>19</b>	Shapes	<b>40</b>
Khami	<b>21</b>	Bottoms	<b>42</b>
Azores	<b>23</b>	Fabrics	<b>44</b>
Delos	<b>25</b>		



# Your ideas ... We make it real!

Our catalogue is only a suggestion for some possible combinations.  
Our collections were designed to be mixed up allowing freedom of choice.  
You can match wall, ceiling, table and floor lamps, and transform your space in something unique, according to your décor and need of light. Enjoy your day and make it beautiful, your imagination is the limit.

From page 35 onwards, you will find a wide variety of alternatives to create your own project.  
In case you don't find what you are looking for or need further information, please let us know.  
We turn your imagination into reality!

by Brilumen



# Taj Mahal



# Taj Mahal



## Ceiling

### Base

ref. 75101.05.0989

### Shape

ref. 22.505030

### Fabric

ref. CBJ.072

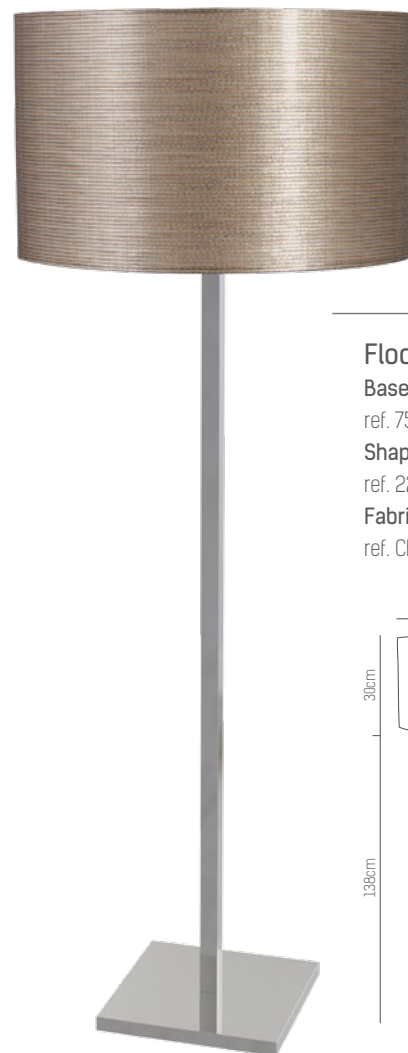
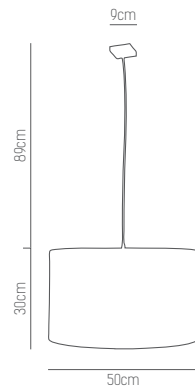

## Floor

### Base

ref. 75015.05.13825

### Shape

ref. 22.505030

### Fabric

ref. CBJ.072

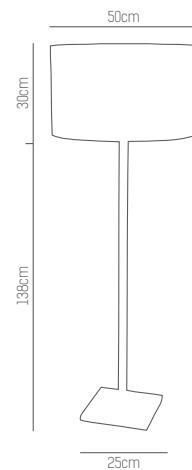

## Table

### Base

ref. 75006.05.3712

### Shape

ref. 22.353520

### Fabric

ref. CBJ.072

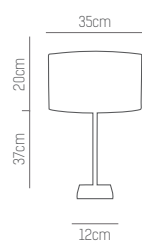

# Mogao



# Mogao



## Ceiling

### Base

ref. 75106.05.0912

### Shape

ref. 21.605030

### Fabric

ref. TCG.80

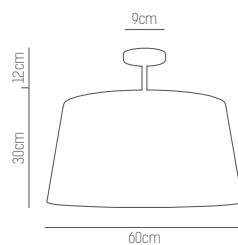

## Table

### Base

ref. 75001.05.3713

### Shape

ref. 20.252018

### Fabric

ref. TCG.80

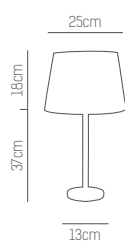

## Floor

### Base

ref. 75012.05.13723

### Shape

ref. 20.403530

### Fabric

ref. TCG.80

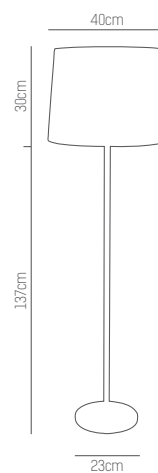



Stari



## Ceiling

### Base

ref. 75102.05.0965

### Shape

ref. 22.404025

### Fabric

ref. GLT.006

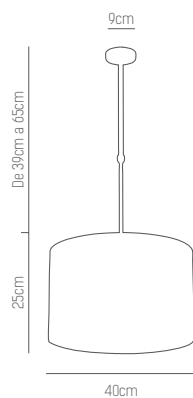

## Table

### Base

ref. 75005.05.4318

### Shape

ref. 22.353520

### Fabric

ref. GLT.006

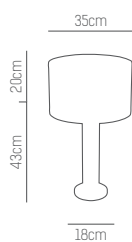

## Floor

### Base

ref. 75014.05.14827

### Shape

ref. 22.505030

### Fabric

ref. GLT.006

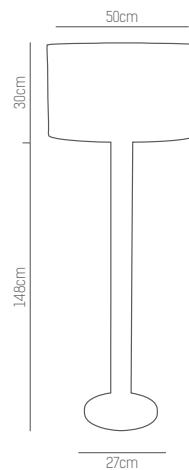

# Dahshur



# Dahshur



## Wall

### Base

ref. 75150.05.0913

### Shape

ref. 24.151112

### Fabric

ref. GLT.008

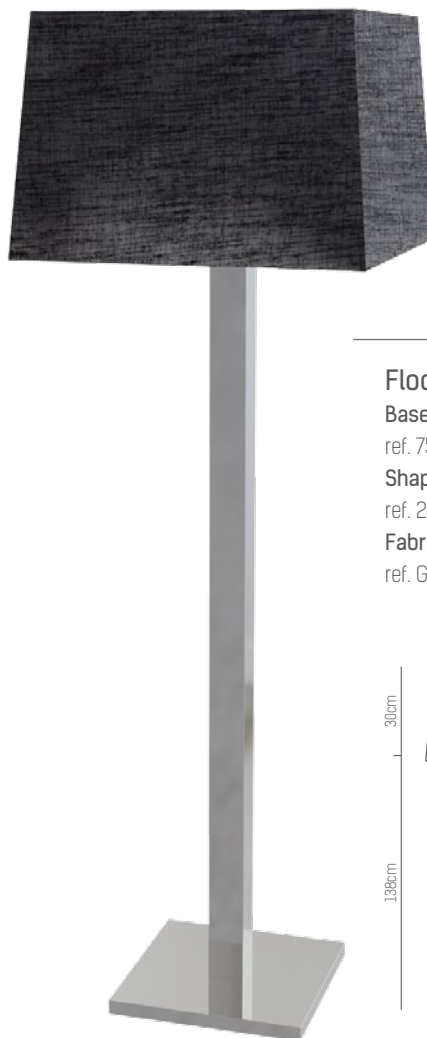
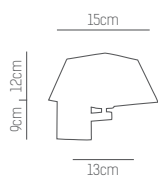

## Floor

### Base

ref. 75016.05.13827

### Shape

ref. 24.454030

### Fabric

ref. GLT.008

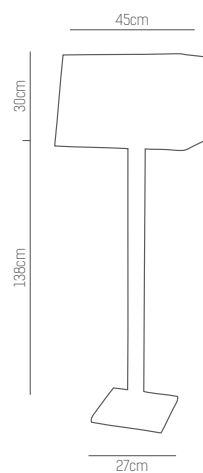

## Table

### Base

ref. 75007.05.4413

### Shape

ref. 24.353025

### Fabric

ref. GLT.008

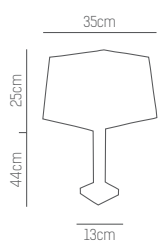

# CHEVRONS





# Chevrons



## Ceiling

### Base

ref. 75104.05.0965

### Shape

ref. 21.605030

### Fabric

ref. CHV.62

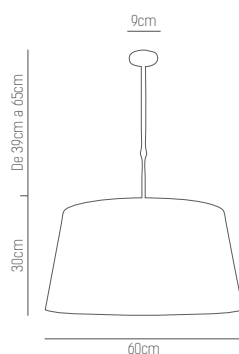

## Ceiling

### Base

ref. 75105.05.0965

### Shape

ref. 23.606030

### Fabric

ref. CHV.63

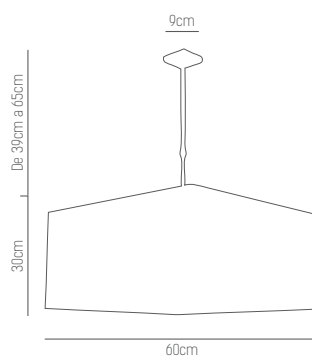

## Ceiling

### Base

ref. 75106.05.0912

### Shape

ref. 22.606035

### Fabric

ref. CHV.61

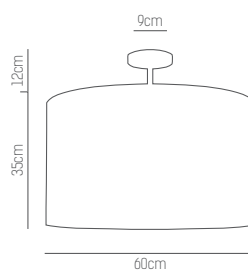

## Ceiling

### Base

ref. 75108.05.1007

### Shape

ref. 22.606035

### Fabric

ref. CHV.64

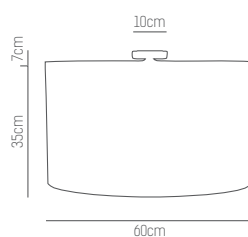

# Nikko



# Nikko



## Table

### Base

ref. 75022.06.4913

### Shape

ref. 22.404025

### Fabric

ref. M29.21

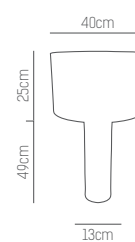

**Base**  
ref. 75022.06.4913  
**Fabric**  
ref. M29.23



**Base**  
ref. 75022.06.4913  
**Fabric**  
ref. M29.24



**Base**  
ref. 75022.06.4913  
**Fabric**  
ref. M29.25



**Base**  
ref. 75022.06.4913  
**Fabric**  
ref. M29.26

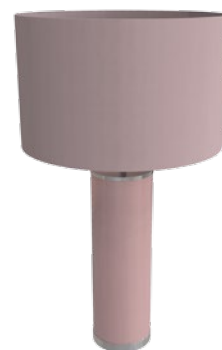

**Base**  
ref. 75022.06.4913  
**Fabric**  
ref. M29.27

# Khami



# Khami



## Table

### Base

ref. 75020.05.4915

### Shape

ref. 22.353520

### Fabric

ref. TCG.80

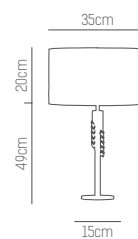

## Ceiling

### Base

ref. 75106.05.0912

### Shape

ref. 22.454530

### Fabric

ref. M29.29

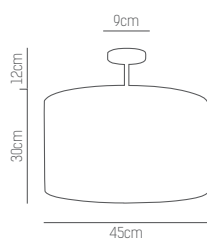

## Ceiling

### Base

ref. 75106.05.0912

### Shape

ref. 22.454530

### Fabric

ref. M29.30

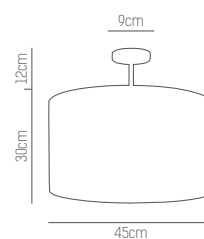

# Azores



# Azores

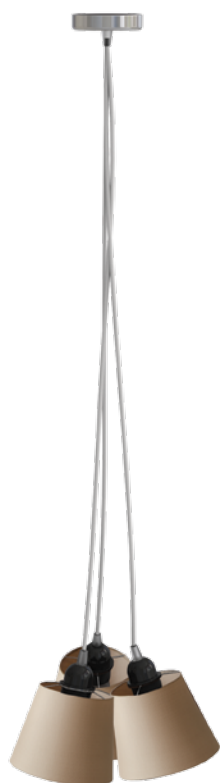

## Ceiling

### Base

ref. 75111.05.1089

### Shape

ref. 20.141011

### Fabric

ref. 123.301

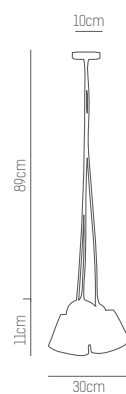

## Floor

### Base

ref. 75017.05.14342

### Shape

ref. 20.605030

### Fabric

ref. 123.301

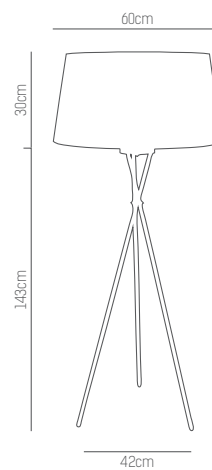

## Table

### Base

ref. 75010.05.4617

### Shape

ref. 20.353025

### Fabric

ref. 123.301

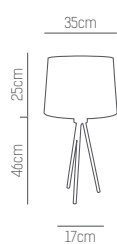



Delos



# Delos



## Floor

### Base

ref. 75019.05.16050

### Shape

ref. 22.606035

### Fabric

ref. M29.28

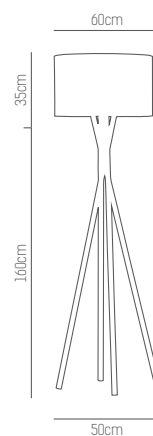

Fabric  
ref. M29.20



Fabric  
ref. M29.27



Fabric  
ref. M29.25



Fabric  
ref. M29.24

## Table

### Base

ref. 75011.05.4617

### Shape

ref. 20.302520



# Durham



# Durham



## Table

### Base

ref. 75004.05.3815

### Shape

ref. 22.353520

### Fabric

ref. MG6.011

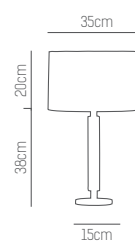

## Wall

### Base

ref. 75151.05.1429

### Shape

ref. 27.201515

### Fabric

ref. MG6.011

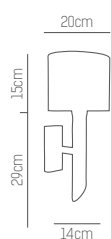

## Table

### Base

ref. 75009.05.3712

### Shape

ref. 23.303020

### Fabric

ref. MG6.011

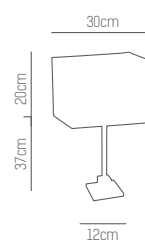

# Lamu



# Lamu



## Wall

### Base

ref. 75153.05.1442

### Shape

ref. 27.201515

### Fabric

ref. GLT.003

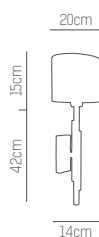

## Table

### Base

ref. 75002.05.4715

### Shape

ref. 27.352025

### Fabric

ref. GLT.003

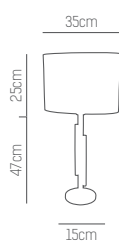

## Floor

### Base

ref. 75013.05.14827

### Shape

ref. 27.503025

### Fabric

ref. GLT.003

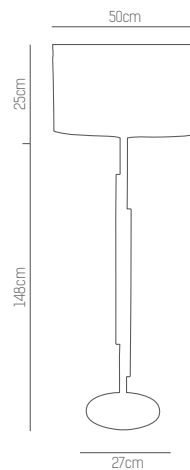



Tikal

# Tikal



## Ceiling

### Base

ref. 75107.05.0912

### Shape

ref. 22.353540

### Fabric

ref. 123.701

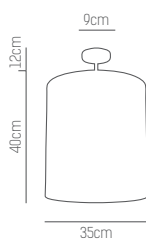

## Ceiling

### Base

ref. 75107.05.0912

### Shape

ref. 22.353540

### Fabric

ref. 123.301



## Ceiling

### Base

ref. 75107.05.0912

### Shape

ref. 22.353540

### Fabric

ref. 123.101



## Ceiling

### Base

ref. 75107.05.0912

### Shape

ref. 22.353540

### Fabric

ref. MG6.012



## Floor

### Base

ref. 75021.05.14048

### Shape

ref. 22.454550

### Fabric

ref. 123.701

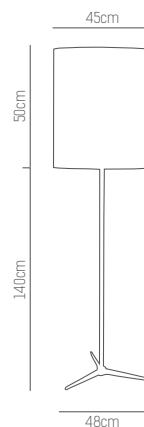

# Tsingy





# Tsingy



## Ceiling

### Base

ref. 75110.05.6461

### Shape

ref. 22.303020

### Fabric

ref. MG6.010

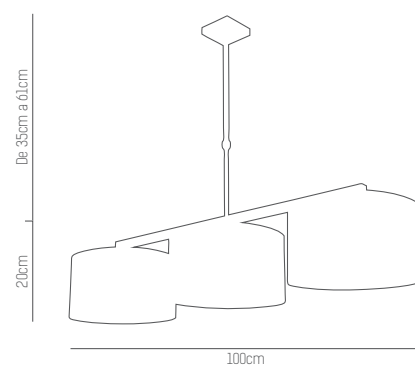

## Ceiling

### Base

ref. 75109.05.4361

### Shape

ref. 26.602530

### Fabric

ref. GLT.001

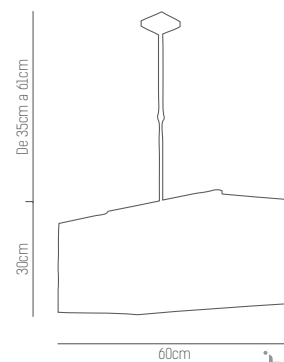

# BASE SE SS



# Wall

For your unique product...  
A wide range of alternatives.



ref. 75150.05.0913



ref. 75152.05.0913



ref. 75153.05.1442



ref. 75151.05.1429



ref. 75154.05.0913

# Ceiling



ref. 75108.05.1007



ref. 75107.05.0912



ref. 75106.05.0912



ref. 75100.05.0989

# Ceiling



ref. 75101.05.0989



ref. 75111.05.1089



ref. 75102.05.0965



ref. 75103.05.0965



ref. 75104.05.0965



ref. 75105.05.0965



ref. 75109.05.4361



ref. 75110.05.6461

# Floor



ref. 75012.05.13723



ref. 75013.05.14827



ref. 75014.05.14827



ref. 75015.05.13825

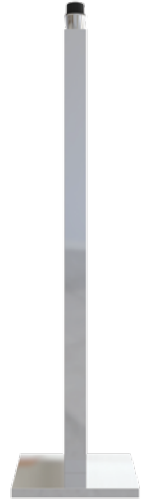

ref. 75016.05.13827



ref. 75021.05.14048



ref. 75017.05.14342



ref. 75018.05.14950



ref. 75019.05.16050

# Table



ref. 75001.05.3713



ref. 75002.05.4715



ref. 75003.05.4316



ref. 75020.05.4915



ref. 75004.05.3815



ref. 75005.05.4318

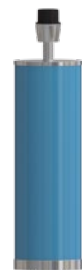

ref. 75022.05.4913.AZ



ref. 75022.05.4913.BJ



ref. 75022.05.4913.BR



ref. 75022.05.4913.CST



ref. 75022.05.4913.PR



ref. 75022.05.4913.RS



ref. 75006.05.2712



ref. 75006.05.3712



ref. 75009.05.3712



ref. 75007.05.4413



ref. 75008.05.5715



ref. 75010.05.4617



ref. 75011.05.4617



Shade Art by  
**brilumen**

SH  
AP  
ES





For your unique product...  
A wide range of alternatives.



## Cylindrical

Ref.	Measures (cm)
22.151515	15 x 15 x 15
22.202015	20 x 20 x 15
22.252517	25 x 25 x 17
22.303020	30 x 30 x 20
22.353520	35 x 35 x 20
22.404025	40 x 40 x 25
22.454525	45 x 45 x 25
22.505030	50 x 50 x 30
22.606035	60 x 60 x 35
22.454550	45 x 45 x 50
22.202030	20 x 20 x 30
22.252530	25 x 25 x 30



## Conical

Ref.	Measures (cm)
20.141011	14 x 10 x 11
20.201510	20 x 15 x 10
20.252018	25 x 20 x 18
20.302520	30 x 25 x 20
20.353025	35 x 30 x 25
20.403530	40 x 35 x 30
20.504030	50 x 40 x 30
20.605030	60 x 50 x 30



## Square

Ref.	Measures (cm)
23.151513	15 x 15 x 13
23.202015	20 x 20 x 15
23.252517	25 x 25 x 17
23.303020	30 x 30 x 20
23.404025	40 x 40 x 25
23.454525	45 x 45 x 25
23.505025	50 x 50 x 25
23.606030	60 x 60 x 30



## Square Conical

Ref.	Measures (cm)
24.151008	15 x 10 x 08
24.151112	15 x 11 x 12
24.201513	20 x 15 x 13
24.252018	25 x 20 x 18
24.302520	30 x 25 x 20
24.353025	35 x 30 x 25
24.403030	40 x 30 x 30
24.504030	50 x 40 x 30



## Rectangular

Ref.	Measures (cm)
26.151012	15 x 10 x 12
26.201515	20 x 15 x 15
26.251720	25 x 17 x 20
26.302020	30 x 20 x 20
26.352325	35 x 23 x 25
26.402020	40 x 20 x 20
26.502025	50 x 20 x 25
26.602530	60 x 25 x 30



## Oval

Ref.	Measures (cm)
27.201515	20 x 15 x 15
27.251715	25 x 17 x 15
27.302017	30 x 20 x 17
27.352025	35 x 20 x 25
27.402520	40 x 25 x 20
27.503025	50 x 30 x 25
27.603030	60 x 30 x 30



## Rectangular Straight Corners

Ref.	Measures (cm)
28.251218	25 x 12 x 18



## Rectangular Round Corners

Ref.	Measures (cm)
29.251218	25 x 12 x 18



## Round Half-Moon

Ref.	Measures (cm)
21.251517	25 x 15 x 17
21.301520	30 x 15 x 20

BO  
TTO  
MS



# Bottoms

For your unique product...  
A wide range of alternatives.



## Round

Ref.	Measures (cm)
22.15	15
22.20	20
22.25	25
22.30	30
22.35	35
22.40	40
22.45	45
22.50	50
22.60	60



## Oval

Ref.	Measures (cm)
27.20	20
27.25	25
27.30	30
27.35	35
27.40	40
27.50	50
27.60	60



## Square

Ref.	Measures (cm)
23.15	15
23.20	20
23.25	25
23.30	30
23.40	40
23.45	45
23.50	50
23.60	60

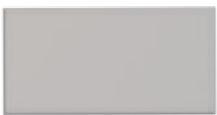

## Rectangular

Ref.	Measures (cm)
26.15	15
26.20	20
26.25	25
26.30	30
26.35	35
26.40	40
26.50	50
26.60	60

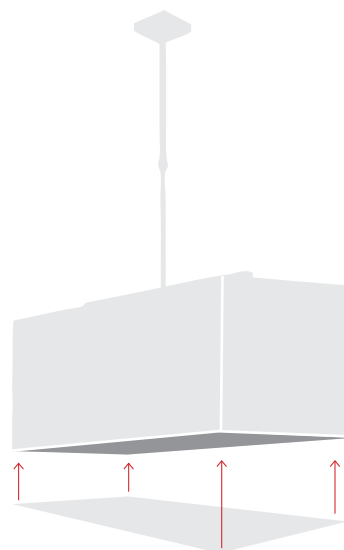

\*Representative drawing

# FABRICS



For your unique product...  
A wide range of alternatives.

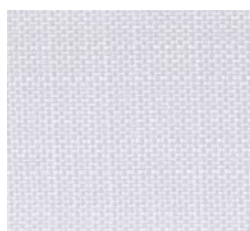
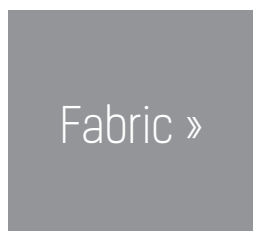

ref. 123.101



ref. 123.201



ref. 123.301

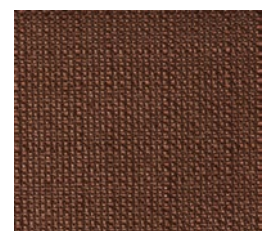

ref. 123.701

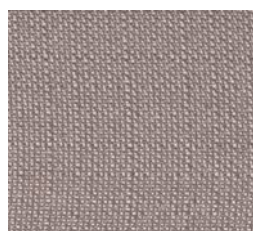

ref. 123.1301



ref. PMB.002



ref. MG6.010



ref. MG6.011



ref. MG6.012



ref. GLT.001



ref. GLT.003



ref. GLT.006



ref. GLT.008



ref. GLT.018

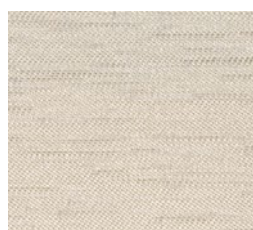

ref. M42.042



ref. CBJ.071



ref. CBJ.072



ref. KKL.60



ref. TCG.80

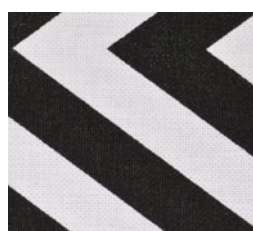

ref. CHV.61



ref. CHV.62



ref. CHV.63



ref. CHV.64



ref. MG6.014



ref. MG6.015



ref. M29.20



ref. M29.27



ref. M29.24



ref. M29.25

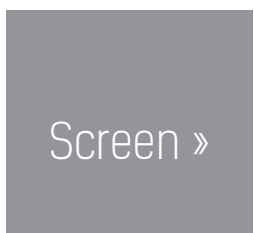

ref. PIR.500

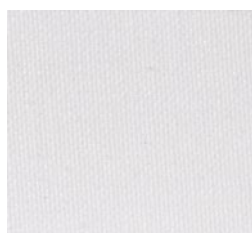

ref. ANT.501



ref. COT.700

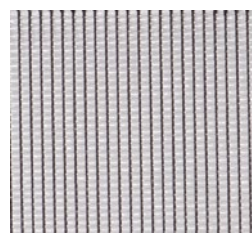

ref. EVS.502



ref. EVS.503



ref. CML.504



ref. CML.505



ref. CML.506



ref. CML.507



ref. CML.509

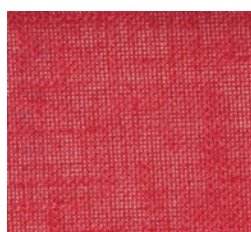

ref. CML.510



ref. MAI.013



ref. SRD.508



ref. SAR.511

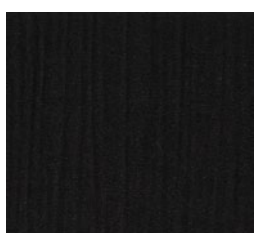

ref. SAR.512

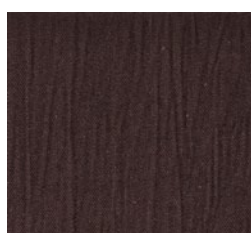

ref. SAR.513



ref. SAR.514



ref. VNZ.515



ref. VNZ.516

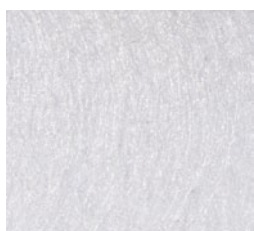

ref. VNZ.517



ref. VNZ.518



ref. VNZ.519

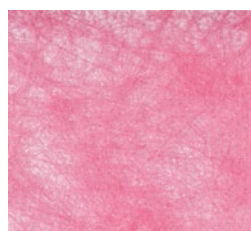

ref. VNZ.520

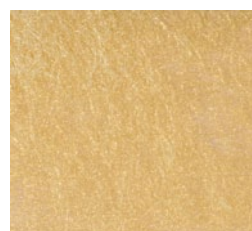

ref. VNZ.521

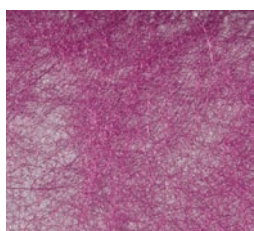

ref. VNZ.522

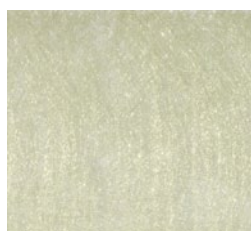

ref. VNZ.523

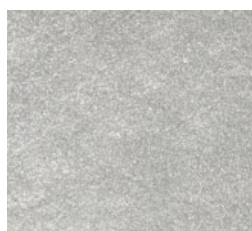

ref. MAL.524

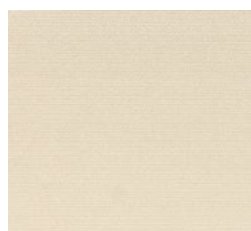

ref. SCL.0101



ref. SCL.102



ref. SCL.103

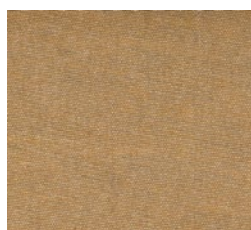

ref. SCL.105



ref. SCL.106



ref. SCL.133



ref. ARN.626



ref. COT.27

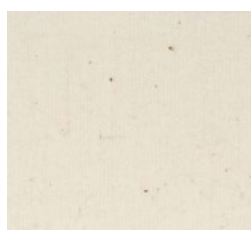

ref. COT.0500



ref. COT.219



ref. COT.525



ref. PCL.33

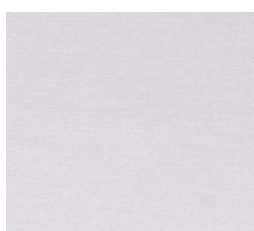

ref. CHZ.01



ref. CHZ.02

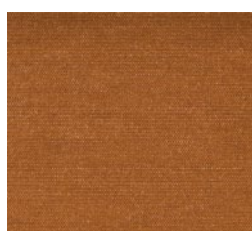

ref. CHZ.07



ref. CHZ.08

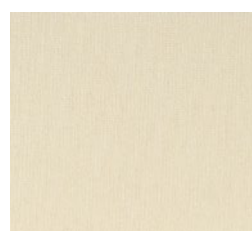

ref. CHZ.12



ref. CHZ.14



ref. CHZ.24

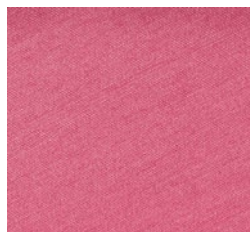

ref. CHZ.29

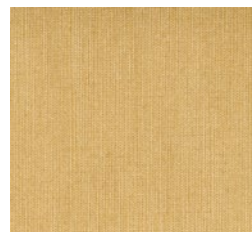

ref. CHZ.033



ref. CHZ.35



ref. CHZ.36

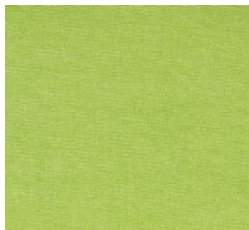

ref. CHZ.44



ref. CHZ.54



ref. CHZ.77



ref. CHZ.123



ref. CHZ.526

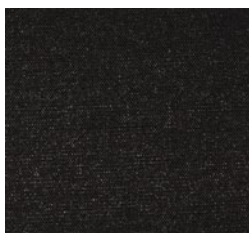

ref. CHZ.527

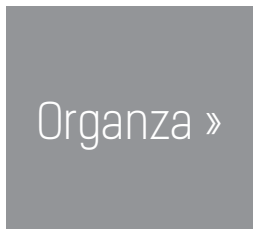

Organza »



ref. ORG.528



ref. ORG.529



ref. ORG.530



ref. ORG.531



ref. ORG.532



ref. ORG.533

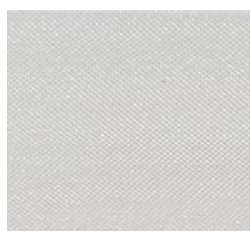

ref. ORG.534



ref. ORG.535



ref. ORG.536





ref. ORG.537



ref. ORG.538



ref. ORG.539

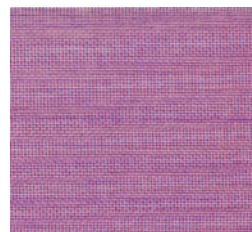

ref. ORG.540



ref. ORG.541



ref. ORG.542



ref. ORG.543



ref. ORG.544



ref. ORG.545



ref. ORG.546



Silk  
Pongé »

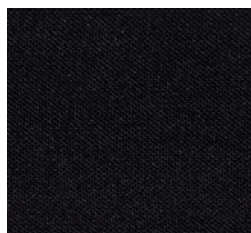

ref. PNG.547



ref. PNG.548



ref. PNG.549



ref. PNG.550



ref. PNG.551



ref. PNG.552



ref. PNG.553

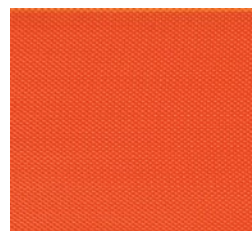

ref. PNG.554

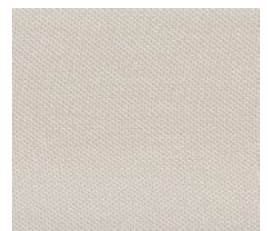

ref. PNG.555



ref. PNG.556



ref. PNG.557





## Shade Art by Brilumen

Rua Oliveira e Sã, nº 200  
Zona Industrial Maia, Setor 1  
4475-263 Maia

Tel. +351 220 920 550  
Fax. +351 220 920 559

apoioclientes@brilumen.com  
www.brilumen.com

