

brilumen®

ORIS Slim Pro

SLIM AND DISTINCTIVE

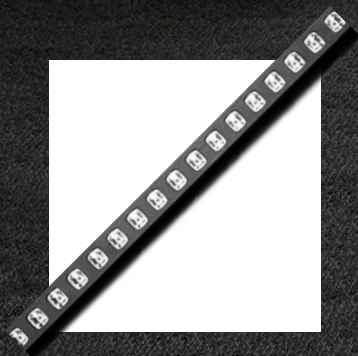
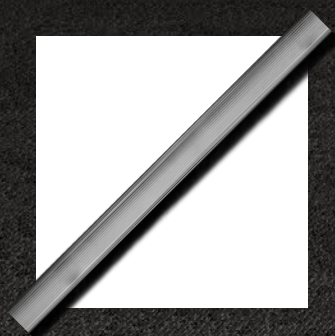
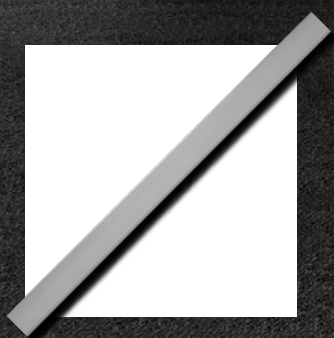

ORIS SLIM PRO

Linear Led Systems
DIRECT LIGHT

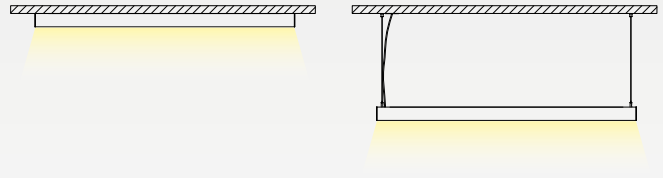
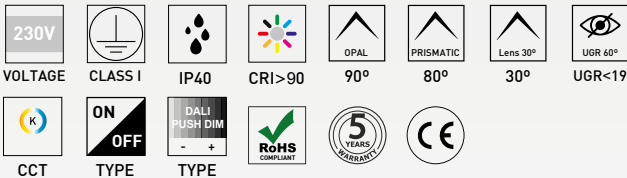

EN

ORIS SLIM PRO, the reduced dimensions of only 26mm in width make this luminaire slim and distinctive. With a minimalist design, this light fixture was designed for refined spaces, where lighting is discreet, but efficient and with a high CRI. Options of direct/indirect light, opal and prismatic diffuser, different beam angles, low glare reflectors and lenses, and comes in versions adaptable for ceilings, surface or walls.

Specially developed to meet the requirements of architects, who are looking for thin and modular lighting fixtures.

With ORIS SLIM PRO, it's possible to mount slim lines of light up to 3,375m without the need of joints.

PT

ORIS SLIM PRO, as dimensões reduzidas de apenas 26mm de largura tornam esta luminária em alumínio esguia e distinta. Com um design minimalista, esta luminária foi pensada para espaços requintados, onde a iluminação seja discreta, mas eficiente, e com elevado CRI. Dispõe das opções de luz direta/indireta, difusor opalino e prismático, diferentes ângulos de feixe, lentes e refletor low glare, e de versões de aplicação no teto ou parede.

Especialmente desenvolvido para responder às exigências dos arquitetos, que procuram linhas de luz finas e modulares.

Com o ORIS SLIM PRO, tem a possibilidade obter linhas finas de luz até 3,375m sem a necessidade de emendas.

FR

ORIS SLIM PRO, ses dimensions étroites de seulement 26mm de large, distinguent ce luminaire comme étant ultra fin. Pourvu d'un design minimaliste, il a été conçu pour des endroits raffinés, où l'éclairage doit être discret, mais efficace et posséder un CRI élevé.

Offre différentes options de lumière directe ou indirecte, d'un diffuseur opale ou prismatique, de différents angles de faisceau, de lentilles et réflecteurs à faible éblouissement et de différentes versions pour une application au plafond ou au mur.

Ce produit a été spécialement conçu pour répondre aux exigences des architectes qui recherchent des lignes d'éclairage fines et modulables.

Avec l'éclairage ORIS SLIM PRO, vous pouvez obtenir de fines lignes lumineuses jusqu'à 3,375 mètres sans jonctions.



GENERAL INFO

Stand Alone Linear light
Suspended / Surface
Class I
IP40

DIFFUSER TYPE

Opal / Prismatic / Lens 30° / Low Glare

LED PCB

3000K / 4000K
CRI>90
Lifetime 50.000h T_p 55°C
3 Steps MacAdam

DIMENSIONS (mm)

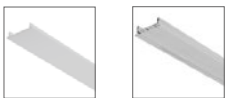
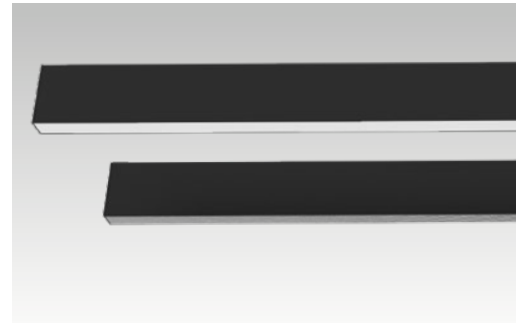
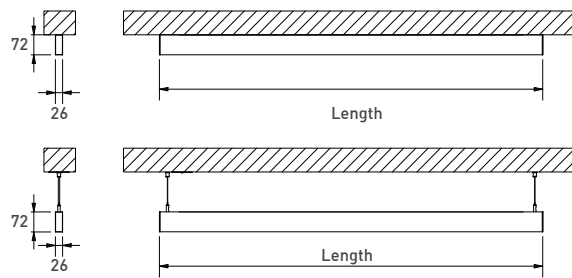

ORIS Slim Pro - OPAL / PRISMATIC Diffuser (09/P8) - CRI>90

Product Table / Tabela de produtos / Tableau des produits

| LENGTH | POWER | LED LUMENS | LUMINAIRE LM | EFFICACY | SUSPENDED | SURFACE |
|---------|--------|------------|--------------|----------|-------------------|-------------------|
| 570 mm | 10,2 W | 1576 lm | 1064 lm | 154 lm/W | 240XX.05BA.9CT.FI | 241XX.05BA.9CT.FI |
| 850 mm | 15,3 W | 2363 lm | 1597 lm | 154 lm/W | 240XX.08BA.9CT.FI | 241XX.08BA.9CT.FI |
| 1130 mm | 20,4 W | 3151 lm | 2129 lm | 154 lm/W | 240XX.11BA.9CT.FI | 241XX.11BA.9CT.FI |
| 1410 mm | 25,5 W | 3939 lm | 2662 lm | 154 lm/W | 240XX.14BA.9CT.FI | 241XX.14BA.9CT.FI |
| 1690 mm | 30,7 W | 4727 lm | 3193 lm | 154 lm/W | 240XX.16BA.9CT.FI | 241XX.16BA.9CT.FI |
| 1970 mm | 35,8 W | 5515 lm | 3726 lm | 154 lm/W | 240XX.19BA.9CT.FI | 241XX.19BA.9CT.FI |
| 2250 mm | 40,9 W | 6302 lm | 4222 lm | 154 lm/W | 240XX.22BA.9CT.FI | 241XX.22BA.9CT.FI |
| 2530 mm | 46,0 W | 7090 lm | 4790 lm | 154 lm/W | 240XX.25BA.9CT.FI | 241XX.25BA.9CT.FI |
| 2810 mm | 51,1 W | 7878 lm | 5323 lm | 154 lm/W | 240XX.28BA.9CT.FI | 241XX.28BA.9CT.FI |
| 3090 mm | 56,2 W | 8666 lm | 5855 lm | 154 lm/W | 240XX.30BA.9CT.FI | 241XX.30BA.9CT.FI |
| 3370 mm | 61,3 W | 9454 lm | 6387 lm | 154 lm/W | 240XX.33BA.9CT.FI | 241XX.33BA.9CT.FI |

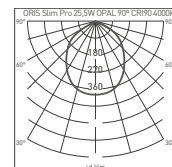

| | | |
|----|--------|--------|
| 1m | Ø2,4m | 834 lx |
| 2m | Ø4,88m | 208 lx |
| 3m | Ø7,82m | 93 lx |
| 4m | Ø9,76m | 52 lx |
| 5m | Ø12,2m | 33 lx |

Note

Full photometrics available online.
Fotometrias completas disponíveis online.
Photométries complètes disponibles en ligne.

*Lumen details for 4000K OPAL / *Detalhes de lumen para 4000K OPALINO / *Détails de lumen pour 4000K OPALE

Select your preferred option

Selecione a sua opção preferida
Sélectionnez votre option préférée

| CONTROL TYPE | XX | BEAM ANGLE | BA | COR. COL. TEMP | CT | FINISHING | FI |
|---------------|----|---------------|----|----------------|----|--|----|
| ON/OFF | NF | Opal 90° | 09 | 3000K | 30 | <input type="checkbox"/> Textured White | TW |
| DALI PUSH DIM | DA | Prismatic 80° | P8 | 4000K | 40 | <input checked="" type="checkbox"/> Textured Black | TB |
| | | | | | | <input type="checkbox"/> Anodized Aluminium | AL |

ORIS Slim Pro - Lens 30° (L3) - CRI>90

Product Table / Tabela de produtos / Tableau des produits

| LENGTH | POWER | LED LUMENS | LUMINAIRE LM | EFFICACY | SUSPENDED | SURFACE |
|---------|---------------|------------|--------------|----------|-------------------|-------------------|
| 570 mm | 7,6 W | 1097 lm | 1006 lm | 145 lm/W | 242XX.05L3.9CT.FI | 243XX.05L3.9CT.FI |
| 850 mm | 11,4 W | 1645 lm | 1507 lm | 145 lm/W | 242XX.08L3.9CT.FI | 243XX.08L3.9CT.FI |
| 1130 mm | 15,2 W | 2194 lm | 2010 lm | 145 lm/W | 242XX.11L3.9CT.FI | 243XX.11L3.9CT.FI |
| 1410 mm | 19,0 W | 2742 lm | 2512 lm | 145 lm/W | 242XX.14L3.9CT.FI | 243XX.14L3.9CT.FI |
| 1690 mm | 22,8 W | 3290 lm | 3015 lm | 145 lm/W | 242XX.16L3.9CT.FI | 243XX.16L3.9CT.FI |
| 1970 mm | 26,6 W | 3839 lm | 3517 lm | 145 lm/W | 242XX.19L3.9CT.FI | 243XX.19L3.9CT.FI |
| 2250 mm | 30,4 W | 4387 lm | 4020 lm | 145 lm/W | 242XX.22L3.9CT.FI | 243XX.22L3.9CT.FI |
| 2530 mm | 34,1 W | 4936 lm | 4525 lm | 145 lm/W | 242XX.25L3.9CT.FI | 243XX.25L3.9CT.FI |
| 2810 mm | 37,9 W | 5484 lm | 5027 lm | 145 lm/W | 242XX.28L3.9CT.FI | 243XX.28L3.9CT.FI |
| 3090 mm | 41,7 W | 6032 lm | 5527 lm | 145 lm/W | 242XX.30L3.9CT.FI | 243XX.30L3.9CT.FI |
| 3370 mm | 45,5 W | 6581 lm | 6032 lm | 145 lm/W | 242XX.33L3.9CT.FI | 243XX.33L3.9CT.FI |

*Lumen details for 4000K / *Detalhes de lumen para 4000K / *Détails de lumen pour 4000K

Select your preferred option

 Selecione a sua opção preferida
 Sélectionnez votre option préférée

| CONTROL TYPE | XX | COR. COL. TEMP | CT | FINISHING | FI |
|---------------|-----------|----------------|-----------|--|-----------|
| ON/OFF | NF | 3000K | 30 | <input type="checkbox"/> Textured White | TW |
| DALI PUSH DIM | DA | 4000K | 40 | <input checked="" type="checkbox"/> Textured Black | TB |
| | | | | <input type="checkbox"/> Anodized Aluminium | AL |

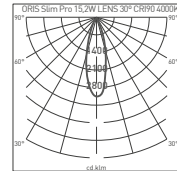
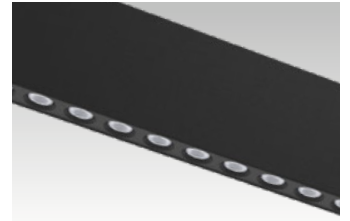
Note

 Full photometrics available online.
 Fotometrias completas disponíveis online.
 Photométries complètes disponibles en ligne.

ORIS Slim Pro - Low Glare Diffuser (U6) - CRI>90

Product Table / Tabela de produtos / Tableau des produits

| LENGTH | POWER | LED LUMENS | LUMINAIRE LM | EFFICACY | SUSPENDED | SURFACE |
|---------|---------------|------------|--------------|----------|-------------------|-------------------|
| 570 mm | 7,6 W | 1097 lm | 967 lm | 145 lm/W | 245XX.05U6.9CT.FI | 247XX.05U6.9CT.FI |
| 850 mm | 11,4 W | 1645 lm | 1448 lm | 145 lm/W | 245XX.08U6.9CT.FI | 247XX.08U6.9CT.FI |
| 1130 mm | 15,2 W | 2194 lm | 1931 lm | 145 lm/W | 245XX.11U6.9CT.FI | 247XX.11U6.9CT.FI |
| 1410 mm | 19,0 W | 2742 lm | 2416 lm | 145 lm/W | 245XX.14U6.9CT.FI | 247XX.14U6.9CT.FI |
| 1690 mm | 22,8 W | 3290 lm | 2900 lm | 145 lm/W | 245XX.16U6.9CT.FI | 247XX.16U6.9CT.FI |
| 1970 mm | 26,6 W | 3839 lm | 3380 lm | 145 lm/W | 245XX.19U6.9CT.FI | 247XX.19U6.9CT.FI |
| 2250 mm | 30,4 W | 4387 lm | 3865 lm | 145 lm/W | 245XX.22U6.9CT.FI | 247XX.22U6.9CT.FI |
| 2530 mm | 34,1 W | 4936 lm | 4347 lm | 145 lm/W | 245XX.25U6.9CT.FI | 247XX.25U6.9CT.FI |
| 2810 mm | 37,9 W | 5484 lm | 4829 lm | 145 lm/W | 245XX.28U6.9CT.FI | 247XX.28U6.9CT.FI |
| 3090 mm | 41,7 W | 6032 lm | 5312 lm | 145 lm/W | 245XX.30U6.9CT.FI | 247XX.30U6.9CT.FI |
| 3370 mm | 45,5 W | 6581 lm | 5798 lm | 145 lm/W | 245XX.33U6.9CT.FI | 247XX.33U6.9CT.FI |

*Lumen details for 4000K / *Detalhes de lumen para 4000K / *Détails de lumen pour 4000K

Select your preferred option

 Selecione a sua opção preferida
 Sélectionnez votre option préférée

| CONTROL TYPE | XX | COR. COL. TEMP | CT | FINISHING | FI |
|---------------|-----------|----------------|-----------|--|-----------|
| ON/OFF | NF | 3000K | 30 | <input type="checkbox"/> Textured White | TW |
| DALI PUSH DIM | DA | 4000K | 40 | <input checked="" type="checkbox"/> Textured Black | TB |
| | | | | <input type="checkbox"/> Anodized Aluminium | AL |

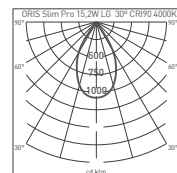
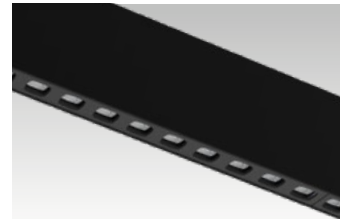

Note

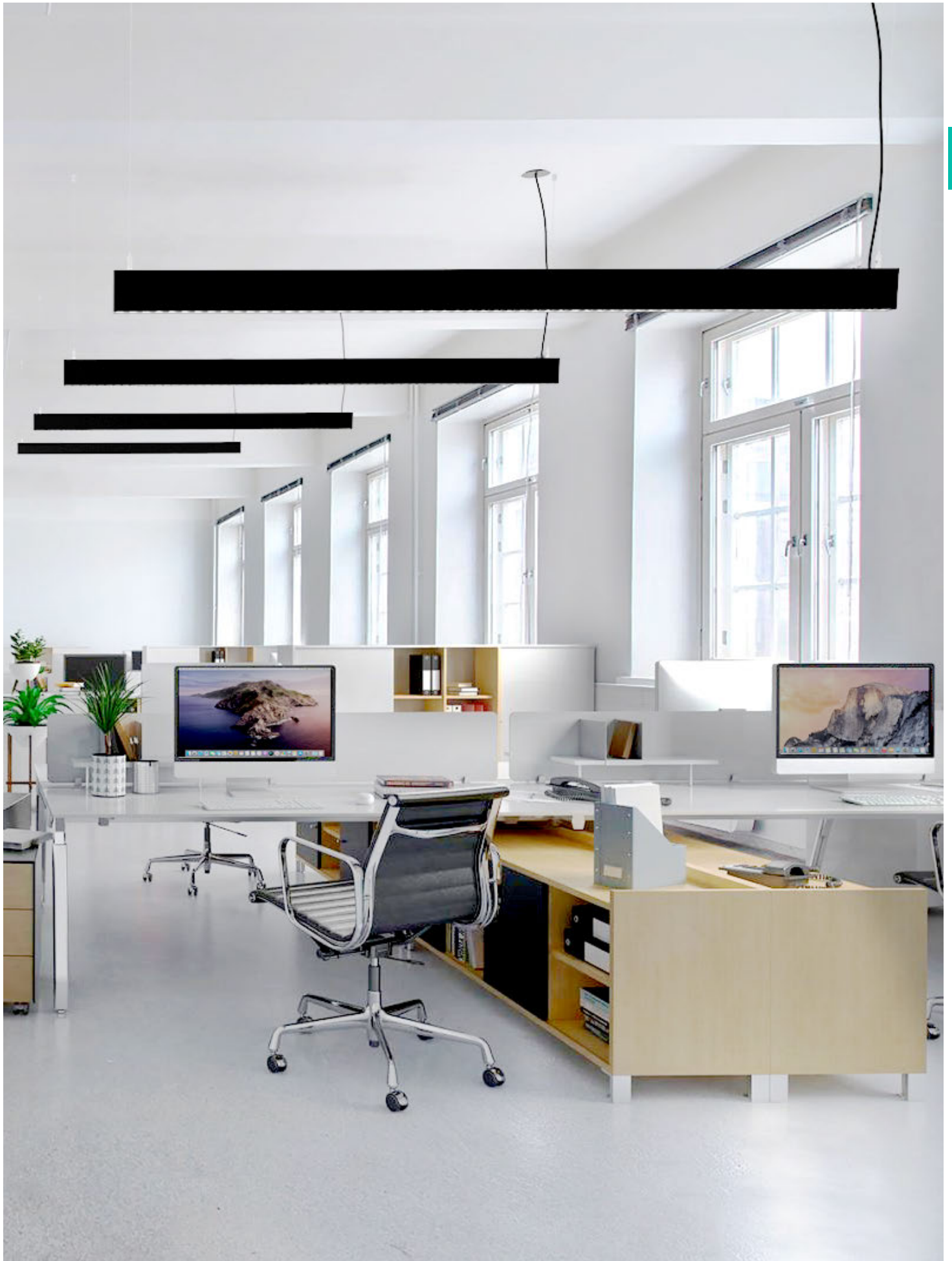
 Full photometrics available online.
 Fotometrias completas disponíveis online.
 Photométries complètes disponibles en ligne.

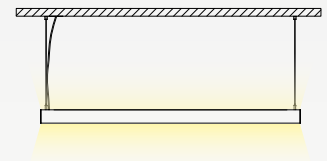
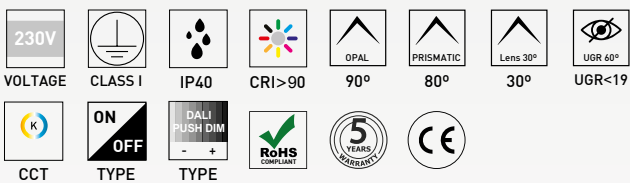

ORIS SLIM PRO

Linear Led Systems
DIRECT / INDIRECT LIGHT



EN

With this version of the ORIS SLIM PRO, it is possible to obtain reduced size light lines while spreading simultaneously direct and indirect light (D / I), thus offering greater freedom for those who design the lighting for a space.

PT

Com esta versão do ORIS SLIM PRO, tem a possibilidade de obter as linhas de luz de dimensões reduzidas, referidas para esta gama, com emissão de luz Direta e Indireta em simultâneo (D/I), permitindo maior liberdade a quem projeta a iluminação para um espaço.

FR

Avec cette version du luminaire ORIS SLIM PRO, il est possible d'obtenir les lignes lumineuses de dimension réduite tout en émettant une lumière directe et indirecte de manière simultanée (D / I), offrant ainsi une plus grande liberté pour ceux qui conçoivent l'éclairage pour un espace.

GENERAL INFO

Stand Alone Linear light
Suspended
Class I
IP40

DIFFUSER TYPE

Opal / Prismatic / Lens 30° / Low Glare

LED PCB

3000K / 4000K
CRI>90
Lifetime 50.000h Tp 55°C
3 Steps MacAdam

DIMENSIONS (mm)

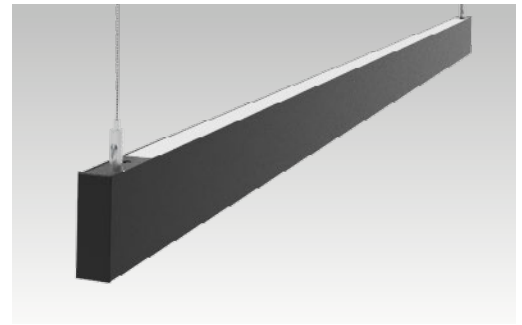
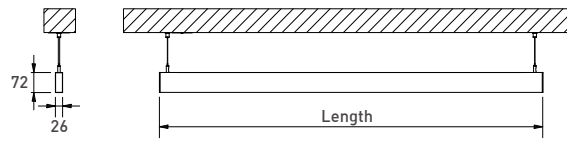

ORIS Slim Pro
OPAL + OPAL Indirect Diffuser - CRI>90

Product Table / Tabela de produtos / Tableau des produits

| LENGTH | POWER | LED LUMENS | LUMINAIRE LM | EFFICACY | SUSPENDED |
|---------|--------|------------|--------------|----------|-------------------|
| 1130 mm | 25,3 W | 3970 lm | 2683 lm | 157 lm/W | 244XX.1109.9CT.FI |
| 1410 mm | 32,0 W | 5031 lm | 3400 lm | 157 lm/W | 244XX.1409.9CT.FI |
| 1690 mm | 38,7 W | 6092 lm | 4116 lm | 157 lm/W | 244XX.1609.9CT.FI |
| 2250 mm | 52,2 W | 8213 lm | 5513 lm | 157 lm/W | 244XX.2209.9CT.FI |
| 2810 mm | 65,6 W | 10335 lm | 6983 lm | 158 lm/W | 244XX.2809.9CT.FI |
| 3370 mm | 79,0 W | 12457 lm | 8416 lm | 158 lm/W | 244XX.3309.9CT.FI |

*Lumen details for 4000K / *Detalhes de lumen para 4000K / *Détails de lumen pour 4000K



Note

Full photometrics available online.
Fotometrias completas disponíveis online.
Photométries complètes disponibles en ligne.

Select your preferred option

Selecione a sua opção preferida
Sélectionnez votre option préférée

| CONTROL TYPE | XX | BEAM ANGLE | COR. COL. TEMP | CT | FINISHING | FI |
|---------------|----|------------|----------------|----|--|----|
| ON/OFF | NF | Opal 90° | 3000K | 30 | <input type="checkbox"/> Textured White | TW |
| DALI PUSH DIM | DA | | 4000K | 40 | <input checked="" type="checkbox"/> Textured Black | TB |
| | | | | | <input type="checkbox"/> Anodized Aluminium | AL |

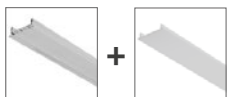

ORIS Slim Pro
PRISMATIC + OPAL Indirect Diffuser - CRI>90

Product Table / Tabela de produtos / Tableau des produits

| LENGTH | POWER | LED LUMENS | LUMINAIRE LM | EFFICACY | SUSPENDED |
|---------|--------|------------|--------------|----------|-------------------|
| 1130 mm | 25,3 W | 3970 lm | 2150 lm | 157 lm/W | 244XX.11P8.9CT.FI |
| 1410 mm | 32,0 W | 5031 lm | 2734 lm | 157 lm/W | 244XX.14P8.9CT.FI |
| 1690 mm | 38,7 W | 6092 lm | 3317 lm | 157 lm/W | 244XX.16P8.9CT.FI |
| 2250 mm | 52,2 W | 8213 lm | 4458 lm | 157 lm/W | 244XX.22P8.9CT.FI |
| 2810 mm | 65,6 W | 10335 lm | 5652 lm | 158 lm/W | 244XX.28P8.9CT.FI |
| 3370 mm | 79,0 W | 12457 lm | 6819 lm | 158 lm/W | 244XX.33P8.9CT.FI |

*Lumen details for 4000K / *Detalhes de lumen para 4000K / *Détails de lumen pour 4000K



Note

Full photometrics available online.
Fotometrias completas disponíveis online.
Photométries complètes disponibles en ligne.

Select your preferred option

Selecione a sua opção preferida
Sélectionnez votre option préférée

| CONTROL TYPE | XX | BEAM ANGLE | COR. COL. TEMP | CT | FINISHING | FI |
|---------------|----|---------------|----------------|----|--|----|
| ON/OFF | NF | Prismatic 80° | 3000K | 30 | <input type="checkbox"/> Textured White | TW |
| DALI PUSH DIM | DA | | 4000K | 40 | <input checked="" type="checkbox"/> Textured Black | TB |
| | | | | | <input type="checkbox"/> Anodized Aluminium | AL |

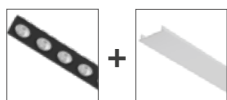
ORIS Slim Pro - Lens 30° + OPAL Indirect - CRI>90

Product Table / Tabela de produtos / Tableau des produits

| LENGTH | POWER | LED LUMENS | LUMINAIRE LM | EFFICACY | SUSPENDED |
|---------|--------|------------|--------------|----------|-------------------|
| 1130 mm | 20,0 W | 3013 lm | 2564 lm | 151 lm/W | 246XX.11L3.9CT.FI |
| 1410 mm | 25,4 W | 3834 lm | 3250 lm | 151 lm/W | 246XX.14L3.9CT.FI |
| 1690 mm | 30,8 W | 4655 lm | 3937 lm | 151 lm/W | 246XX.16L3.9CT.FI |
| 2250 mm | 41,6 W | 6298 lm | 5312 lm | 151 lm/W | 246XX.22L3.9CT.FI |
| 2810 mm | 52,4 W | 7941 lm | 6687 lm | 151 lm/W | 246XX.28L3.9CT.FI |
| 3370 mm | 63,3 W | 9584 lm | 8061 lm | 151 lm/W | 246XX.33L3.9CT.FI |

*Lumen details for 4000K / *Detalhes de lumen para 4000K / *Détails de lumen pour 4000K

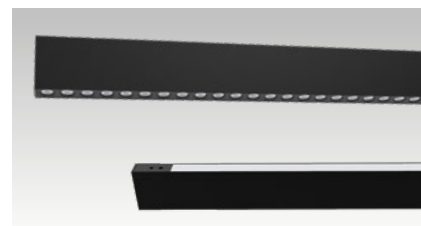

Note

 Full photometrics available online.
 Fotometrias completas disponíveis online.
 Photométries complètes disponibles en ligne.

Select your preferred option

 Selecione a sua opção preferida
 Sélectionnez votre option préférée

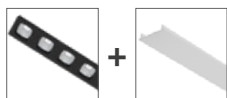
| CONTROL TYPE | XX | BEAM ANGLE | | COR. COL. TEMP | CT | FINISHING | | FI |
|---------------|----|------------|----|----------------|----|-------------------------------------|--------------------|----|
| ON/OFF | NF | 30° | L3 | 3000K | 30 | <input type="checkbox"/> | Textured White | TW |
| DALI PUSH DIM | DA | | | 4000K | 40 | <input checked="" type="checkbox"/> | Textured Black | TB |
| | | | | | | <input type="checkbox"/> | Anodized Aluminium | AL |

ORIS Slim Pro - Low Glare Diffuser + OPAL Indirect - CRI>90

Product Table / Tabela de produtos / Tableau des produits

| LENGTH | POWER | LED LUMENS | LUMINAIRE LM | EFFICACY | SUSPENDED |
|---------|--------|------------|--------------|----------|-------------------|
| 1130 mm | 20,0 W | 3013 lm | 2484 lm | 151 lm/W | 246XX.11U6.9CT.FI |
| 1410 mm | 25,4 W | 3834 lm | 3154 lm | 151 lm/W | 246XX.14U6.9CT.FI |
| 1690 mm | 30,8 W | 4655 lm | 3823 lm | 151 lm/W | 246XX.16U6.9CT.FI |
| 2250 mm | 41,6 W | 6298 lm | 5156 lm | 151 lm/W | 246XX.22U6.9CT.FI |
| 2810 mm | 52,4 W | 7941 lm | 6489 lm | 151 lm/W | 246XX.28U6.9CT.FI |
| 3370 mm | 63,3 W | 9584 lm | 7827 lm | 151 lm/W | 246XX.33U6.9CT.FI |

*Lumen details for 4000K / *Detalhes de lumen para 4000K / *Détails de lumen pour 4000K



Note

 Full photometrics available online.
 Fotometrias completas disponíveis online.
 Photométries complètes disponibles en ligne.

Select your preferred option

 Selecione a sua opção preferida
 Sélectionnez votre option préférée

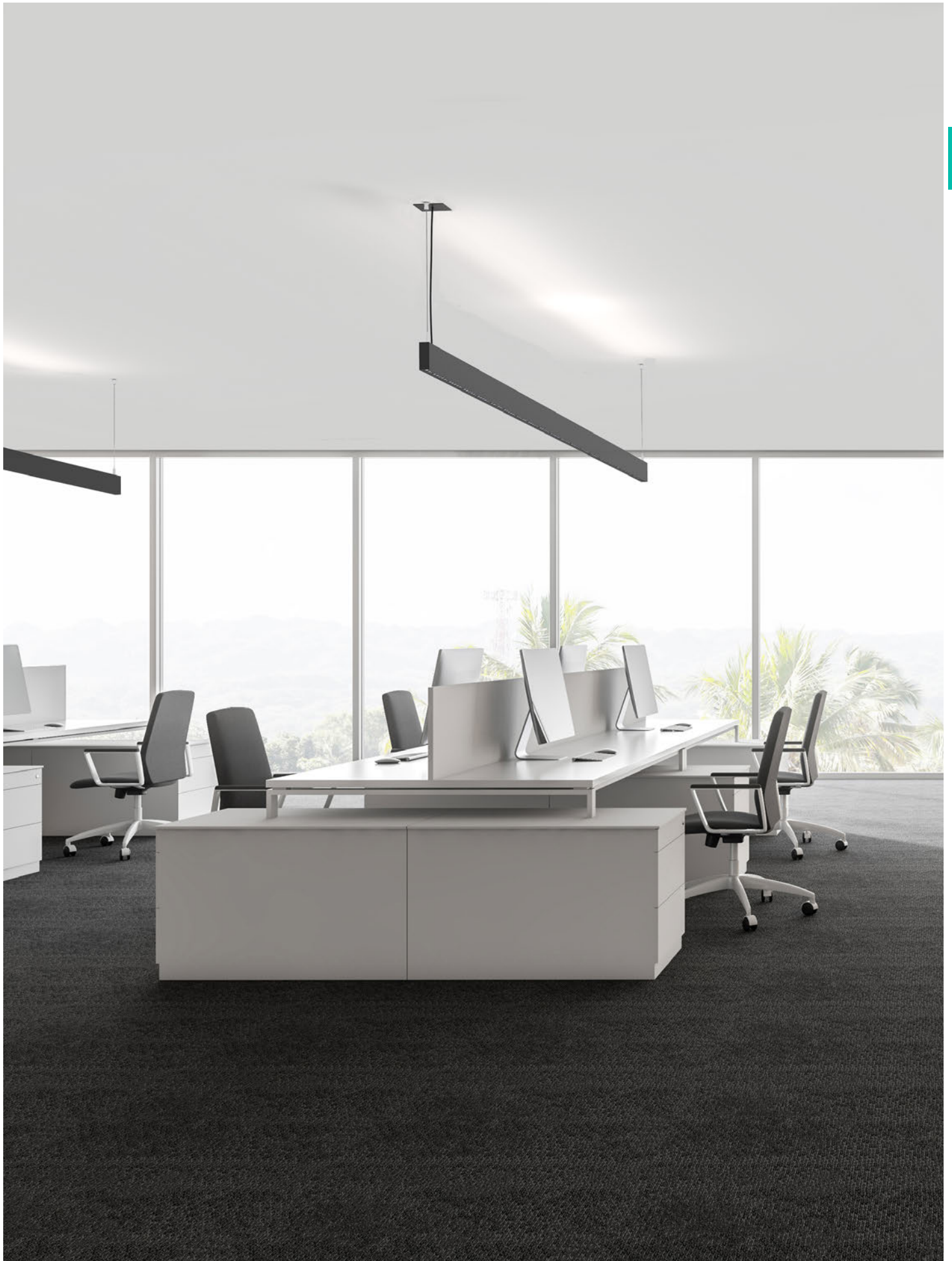
| CONTROL TYPE | XX | BEAM ANGLE | | COR. COL. TEMP | CT | FINISHING | | FI |
|---------------|----|------------|----|----------------|----|-------------------------------------|--------------------|----|
| ON/OFF | NF | 60° | U6 | 3000K | 30 | <input type="checkbox"/> | Textured White | TW |
| DALI PUSH DIM | DA | | | 4000K | 40 | <input checked="" type="checkbox"/> | Textured Black | TB |
| | | | | | | <input type="checkbox"/> | Anodized Aluminium | AL |



LINEAR LED SYSTEMS

ORIS SLIM PRO

DIRECT / INDIRECT LIGHT

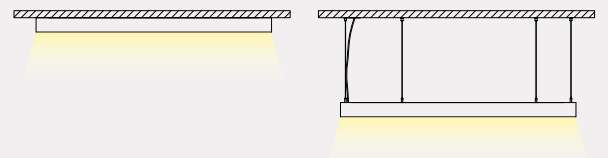
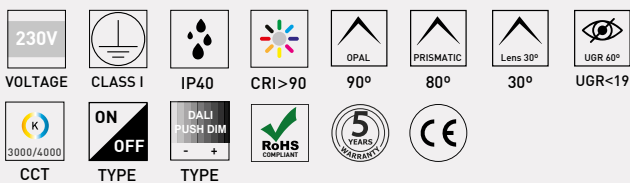
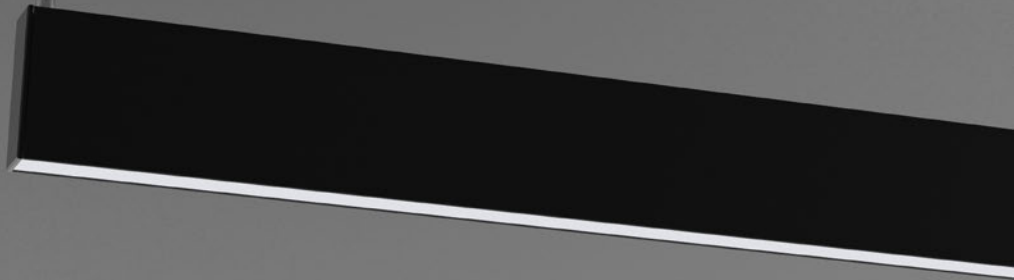

EN

The "Linear System", are personalized light lines tailored to your projects, designed to enrich special places.

With the "Linear System", you can customize your fixture by incorporating in a single line, different types of lighting sources or beam angles, prismatic diffuser or recessed spotlights that offer a particularly low-glare level.

Combine the modules as desired to create your own ideal light line, adjusted to your needs.

Start by selecting the external profile you want (suspended, surface mounted, white, black, etc.) then choose the light engine (colour temperature 3000K or 4000K, opal or prismatic diffuser, low UGR, CRI, ON/OFF regulation, DALI, etc.), then choose the corner options in L, T, X or Y, and finally, the accessories.

At the end, feel the satisfaction of having created your own lighting line!

PT

Os "Linear System" são linhas de luz personalizadas, desenhadas para enriquecer locais especiais e à medida dos seus projetos.

Nos "Linear System" pode personalizar as luminárias, incorporando numa única linha de luz, diferentes tipos de iluminação ou ângulos de feixe, difusor prismático ou soluções com spots de luz recuados que permitem um nível de encandeamto particularmente baixo.

Conjuge os nossos "módulos" para criar a linha de luz ideal, ajustada à medida das suas necessidades e preferências.

Comece por seleccionar o perfil externo que pretende (suspenso, saliente, branco, preto...) depois escolha o motor de luz (cor 3000K ou 4000K, difusor opalino, prismático, baixo UGR, CRI, regulação on/off, Dali, ...) de seguida escolha as uniões de canto em L, T, X ou Y... e por fim, os acessórios.

No fim sinta o resultado "Esta é a MINHA linha de luz".

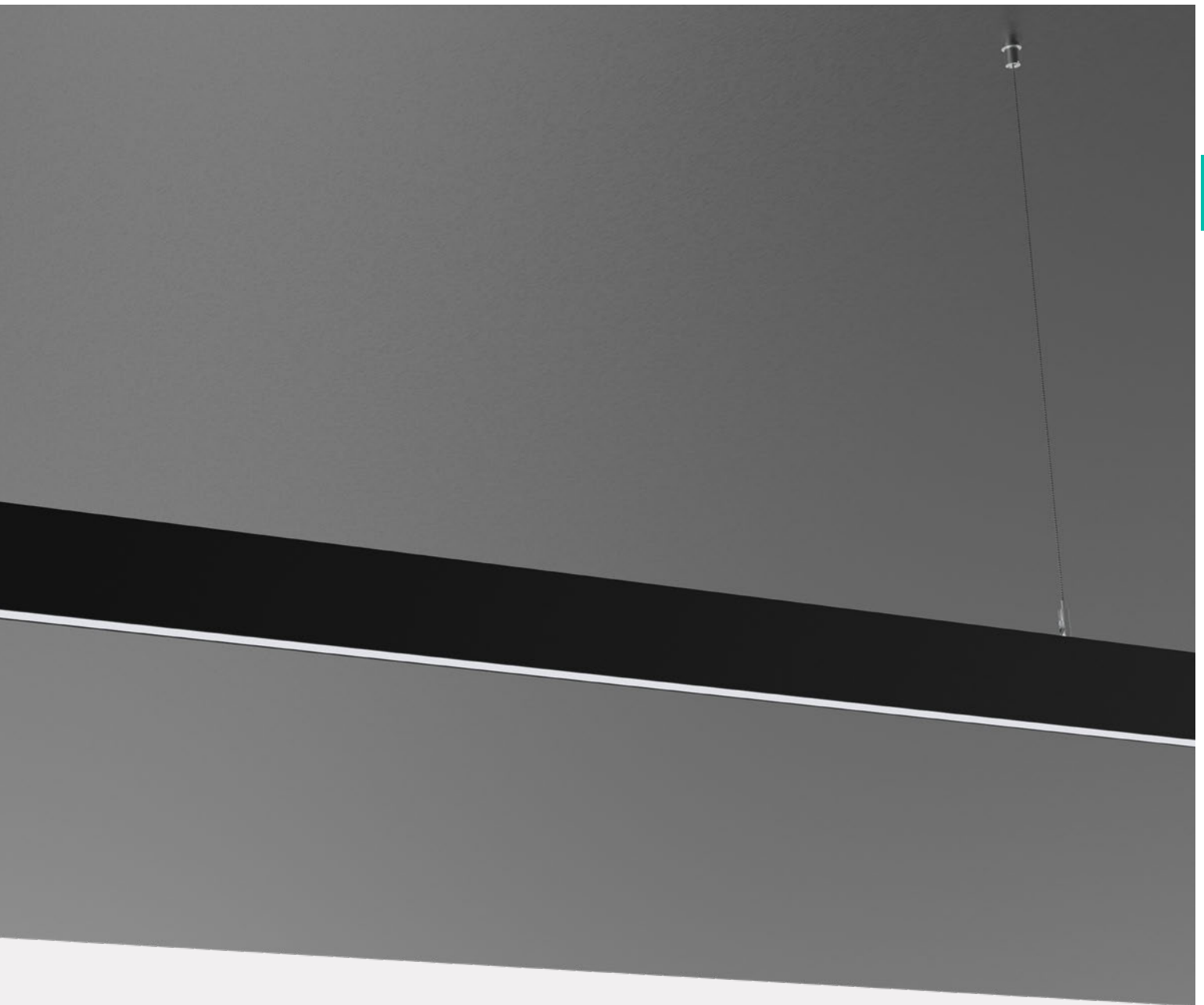

FR

Les systèmes linéaires, ou « Linear System », sont un système de lignes lumineuses personnalisées, conçues pour s'adapter à vos projets et pour enrichir des espaces particuliers.

Avec le "Linear System", vous pouvez personnaliser votre luminaire en incorporant dans une même ligne, différents types d'éclairage ou d'angles de faisceau, un diffuseur prismatique ou des mini spots encastrés, qui offrent un niveau d'éblouissement particulièrement faible.

Combinez à souhait les modules afin de créer votre propre ligne lumineuse, adaptée à vos besoins.

Commencez par sélectionner le profil extérieur que vous souhaitez (suspendu, en saillie, blanc, noir, etc.) puis choisissez le module d'éclairage (température de couleur 3000K ou 4000K, diffuseur opale ou prismatique, UGR bas, CRI, régulation ON/OFF, DALI, etc.), ensuite, choisissez les options d'angle en L, T, X ou Y, et enfin, les accessoires.

À la fin, ressentez la satisfaction d'avoir créé votre propre ligne de lumière!

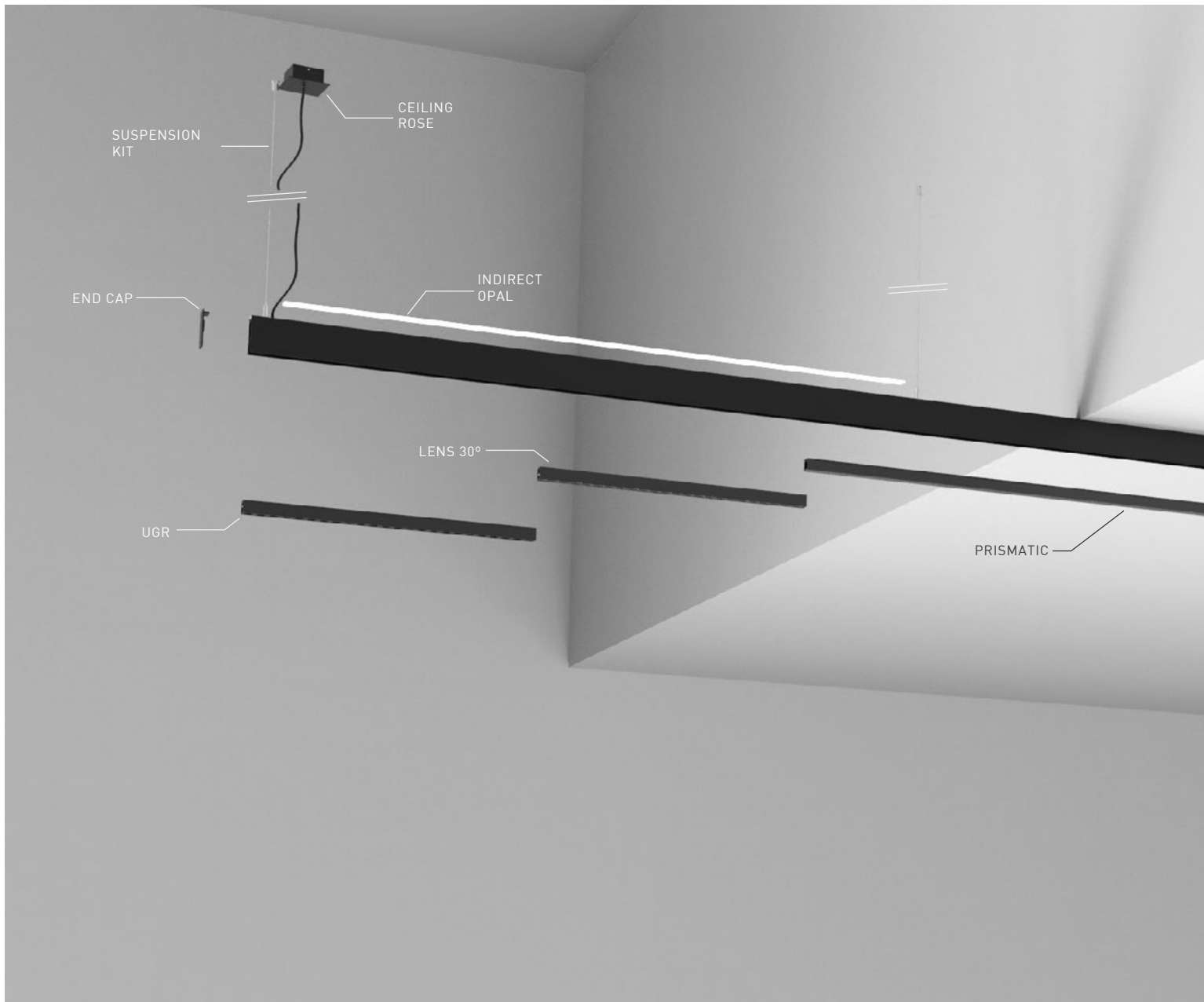

ORDER BUILD

Configurador de encomenda / Configurateur de commande

Choose External Profile
Escolha o Perfil Externo
Choisissez le Profil Externe

1



SUSPENDED
SUSPENSO
SUSPENDU



SURFACE
SUPERFÍCIE
EN SAILLIE

Choose the LED Module and Diffuser / Optics
Escolha o Módulo de LED e o Difusor / Ópticos
Choisissez le Module de LED et le Diffuseur / Optiques

2

2.1 Direct Light - CRI90



ON/OFF
ON/OFF
ON/OFF



DALI
DALI
DALI

2.2 Indirect Light - CRI90



ON/OFF
ON/OFF
ON/OFF



DALI
DALI
DALI



Choose Corner Joint
 Escolha Uniões de Canto
 Choisissez le Jonction d' Angle

Choose Accessories
 Escolha os Acessórios
 Choisissez les Accessoires

3

4



L - CORNER JOINT
 UNIÃO DE CANTO
 JONCTION D' ANGLE



T- CORNER JOINT
 UNIÃO DE CANTO
 JONCTION D' ANGLE



BLIND COVER
 TAMPA CEGA
 CACHE AVEUGLE



POWER CABLES
 CABOS DE ALIMENTAÇÃO
 CÂBLES D'ALIMENTATION



SUSPENSION KITS
 KITS DE SUSPENSÃO
 KITS DE SUSPENSION



CASAMBI
 CASAMBI
 CASAMBI



END CAPS
 TOPOS
 EMBOUTS



DIFFUSER NON LIGHTED
 DIFUSOR NÃO ILUMINADO
 DIFFUSEUR NON ÉCLAIRÉ



CEILING ROSE
 FLORÃO DE TETO
 COUPE DE PLAFOND



1 External Profile

Perfil Externo / Profil Externe

| LENGTH | SUSPENDED/SURFACE |
|--------|-------------------|
| 570 | 2600570.FI |
| 850 | 2600850.FI |
| 1130 | 2601130.FI |
| 1410 | 2601410.FI |
| 1690 | 2601690.FI |
| 1970 | 2601970.FI |
| 2250 | 2602250.FI |
| 2530 | 2602530.FI |
| 2810 | 2602810.FI |

Select your preferred option

Selecione a sua opção preferida
Sélectionnez votre option préférée

| FINISHING | FI |
|--|-----------|
| <input type="checkbox"/> Textured White | TW |
| <input checked="" type="checkbox"/> Textured Black | TB |
| <input type="checkbox"/> Anodized Aluminium | AL |

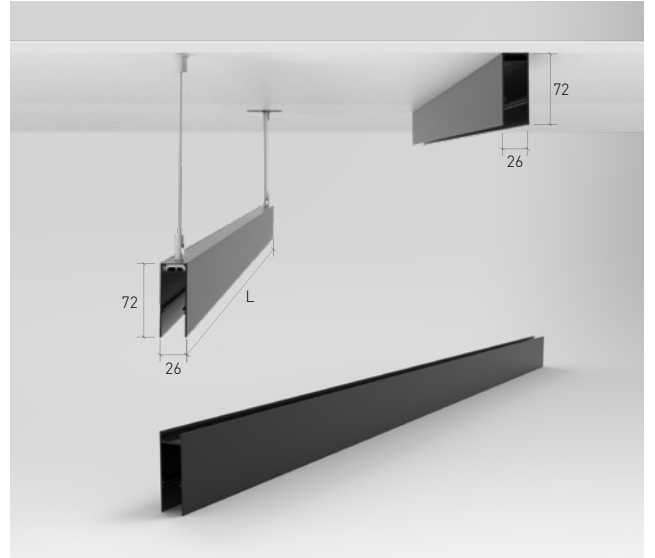

2 LED Module and Diffuser / Optics

Módulo de LED e Difusor - Ópticos / Module de LED et Diffuseur - Optiques

2.1 Direct Light - CRI90

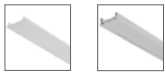

Led Module with OPAL / PRISMATIC Diffuser (09/P8) - CRI>90

Product Table / Tabela de produtos / Tableau des produits

| CONTROL TYPE | LENGTH | POWER | CCT | LED LUMENS | LUMINAIRE LM | EFFICACY | ORDER CODE |
|--------------|---------------|--------|-------|------------|--------------|----------|----------------|
| NF, DA | 2 x 290 mm ** | 10,2 W | 3000K | 1498 lm | 1011 lm | 147 lm/W | 263XX.02BA.930 |
| | | | 4000K | 1576 lm | 1064 lm | 154 lm/W | 263XX.02BA.940 |
| | 570 mm | 10,2 W | 3000K | 1498 lm | 1011 lm | 147 lm/W | 263XX.05BA.930 |
| | | | 4000K | 1576 lm | 1064 lm | 154 lm/W | 263XX.05BA.940 |
| | 850 mm | 15,3 W | 3000K | 2246 lm | 1518 lm | 147 lm/W | 263XX.08BA.930 |
| | | | 4000K | 2363 lm | 1597 lm | 154 lm/W | 263XX.08BA.940 |
| | 1130 mm | 20,4 W | 3000K | 2995 lm | 2024 lm | 147 lm/W | 263XX.11BA.930 |
| | | | 4000K | 3151 lm | 2129 lm | 154 lm/W | 263XX.11BA.940 |
| | 1410 mm | 25,5 W | 3000K | 3744 lm | 2530 lm | 147 lm/W | 263XX.14BA.930 |
| | | | 4000K | 3939 lm | 2662 lm | 154 lm/W | 263XX.14BA.940 |

*Lumen details for 4000K OPAL / *Detalhes de lumen para 4000K OPALINO / *Détails de lumen pour 4000K OPALE

Select your preferred option

Selecione a sua opção preferida
Sélectionnez votre option préférée

| CONTROL TYPE | XX | BEAM ANGLE | BA |
|---------------|----|---------------|-----------|
| ON/OFF | NF | Opal 90° | 09 |
| DALI PUSH DIM | DA | Prismatic 80° | P8 |

**Modules to be applied in same fixture up to 1410mm
** Módulos a serem aplicados na mesma luminária até 1410 mm
** Modules à appliquer dans le même luminaire jusqu'à 1410 mm

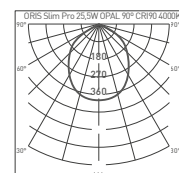
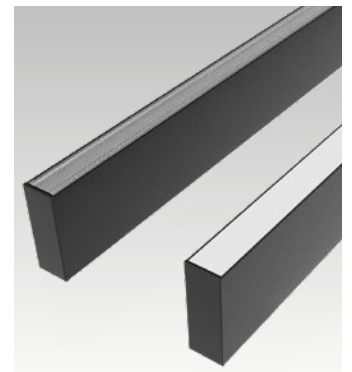

Note

Full photometrics available online.
Fotometrias completas disponíveis online.
Photométries complètes disponibles en ligne.



Led Module with Lens 30° (L3) - CRI>90

Product Table / Tabela de produtos / Tableau des produits

| CONTROL TYPE | LENGTH | POWER | CCT | LED LUMENS | LUMINAIRE LM | EFFICACY | ORDER CODE |
|--------------|---------------|--------|-------|------------|--------------|----------|-------------------|
| NF, DA | 2 x 290 mm ** | 7,6 W | 3000K | 1044 lm | 957 lm | 138 lm/W | 264XX.02L3.930.BL |
| | | | 4000K | 1097 lm | 1006 lm | 145 lm/W | 264XX.02L3.940.BL |
| | 570 mm | 7,6 W | 3000K | 1044 lm | 957 lm | 138 lm/W | 264XX.05L3.930.BL |
| | | | 4000K | 1097 lm | 1006 lm | 145 lm/W | 264XX.05L3.940.BL |
| | 850 mm | 11,4 W | 3000K | 1566 lm | 1435 lm | 138 lm/W | 264XX.08L3.930.BL |
| | | | 4000K | 1645 lm | 1507 lm | 145 lm/W | 264XX.08L3.940.BL |
| | 1130 mm | 15,2 W | 3000K | 2088 lm | 1913 lm | 138 lm/W | 264XX.11L3.930.BL |
| | | | 4000K | 2194 lm | 2010 lm | 145 lm/W | 264XX.11L3.940.BL |
| | 1410 mm | 19,0 W | 3000K | 2610 lm | 2391 lm | 138 lm/W | 264XX.14L3.930.BL |
| | | | 4000K | 2742 lm | 2512 lm | 145 lm/W | 264XX.14L3.940.BL |

*Lumen details for 4000K / *Detalhes de lumen para 4000K / *Détails de lumen pour 4000K

Select your preferred option

Selecione a sua opção preferida
Sélectionnez votre option préférée

| CONTROL TYPE | XX | BEAM ANGLE | |
|---------------|----|------------|----|
| ON/OFF | NF | 30° | L3 |
| DALI PUSH DIM | DA | | |

**Modules to be applied in same fixture up to 1410mm

** Módulos a serem aplicados na mesma luminária até 1410 mm

** Modules à appliquer dans le même luminaire jusqu'à 1410 mm

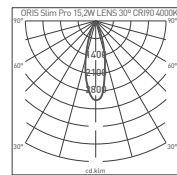
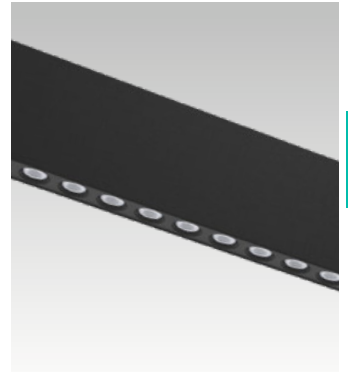

Note

Full photometrics available online.
Fotometrias completas disponíveis online.
Photométries complètes disponibles en ligne.



Led Module with Low Glare Diffuser (U6) - CRI>90

Product Table / Tabela de produtos / Tableau des produits

| CONTROL TYPE | LENGTH | POWER | CCT | LED LUMENS | LUMINAIRE LM | EFFICACY | ORDER CODE |
|--------------|---------------|--------|-------|------------|--------------|----------|-------------------|
| NF, DA | 2 x 290 mm ** | 7,6 W | 3000K | 1044 lm | 920 lm | 138 lm/W | 267XX.02U6.930.BL |
| | | | 4000K | 1097 lm | 967 lm | 145 lm/W | 267XX.02U6.940.BL |
| | 570 mm | 7,6 W | 3000K | 1044 lm | 920 lm | 138 lm/W | 267XX.05U6.930.BL |
| | | | 4000K | 1097 lm | 967 lm | 145 lm/W | 267XX.05U6.940.BL |
| | 850 mm | 11,4 W | 3000K | 1566 lm | 1379 lm | 138 lm/W | 267XX.08U6.930.BL |
| | | | 4000K | 1645 lm | 1448 lm | 145 lm/W | 267XX.08U6.940.BL |
| | 1130 mm | 15,2 W | 3000K | 2088 lm | 1838 lm | 138 lm/W | 267XX.11U6.930.BL |
| | | | 4000K | 2194 lm | 1931 lm | 145 lm/W | 267XX.11U6.940.BL |
| | 1410 mm | 19,0 W | 3000K | 2610 lm | 2300 lm | 138 lm/W | 267XX.14U6.930.BL |
| | | | 4000K | 2742 lm | 2416 lm | 145 lm/W | 267XX.14U6.940.BL |

*Lumen details for 4000K / *Detalhes de lumen para 4000K / *Détails de lumen pour 4000K

Select your preferred option

Selecione a sua opção preferida
Sélectionnez votre option préférée

| CONTROL TYPE | XX | BEAM ANGLE | |
|---------------|----|------------|----|
| ON/OFF | NF | 60° | U6 |
| DALI PUSH DIM | DA | | |

**Modules to be applied in same fixture up to 1410mm

** Módulos a serem aplicados na mesma luminária até 1410 mm

** Modules à appliquer dans le même luminaire jusqu'à 1410 mm

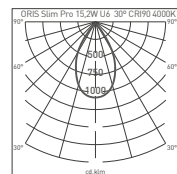
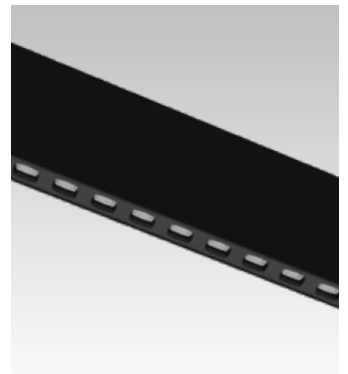

Note

Full photometrics available online.
Fotometrias completas disponíveis online.
Photométries complètes disponibles en ligne.

2.2 Indirect Light - CRI90



Led Module with INDIRECT OPAL Diffuser (09) - CRI>90

Product Table / Tabela de produtos / Tableau des produits

| CONTROL TYPE | LENGTH | POWER | CCT | LED LUMENS | LUMINAIRE LM | EFFICACY | ORDER CODE |
|--------------|---------|-------|-------|------------|--------------|----------|----------------|
| NF, DA | 850 mm | 4,8 W | 3000K | 780 lm | 527 lm | 161 lm/W | 265XX.0809.930 |
| | | | 4000K | 819 lm | 553 lm | 169 lm/W | 265XX.0809.940 |
| | 1130 mm | 6,4 W | 3000K | 1040 lm | 703 lm | 161 lm/W | 265XX.1109.930 |
| | | | 4000K | 1092 lm | 738 lm | 169 lm/W | 265XX.1109.940 |
| | 1410 mm | 8,1 W | 3000K | 1300 lm | 879 lm | 161 lm/W | 265XX.1409.930 |
| | | | 4000K | 1365 lm | 922 lm | 169 lm/W | 265XX.1409.940 |

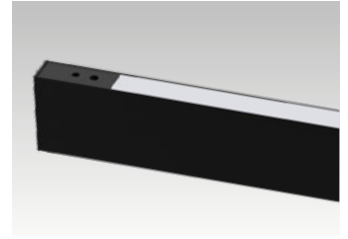

Note

Full photometrics available online.
Fotometrias completas disponíveis online.
Photométries complètes disponibles en ligne.

Select your preferred option

Selecione a sua opção preferida
Sélectionnez votre option préférée

| CONTROL TYPE | XX |
|---------------|----|
| ON/OFF | NF |
| DALI PUSH DIM | DA |

3 CORNER JOINT

União De Canto / Jonction d'Angle



CORNER JOINT

Product Table / Tabela de produtos / Tableau des produits

| CORNER | SUSPENDED / SURFACE |
|-----------------------------------|---------------------|
| L - Corner joint with blind cover | 80303024.FI |
| T - Corner joint with blind cover | 80303025.FI |

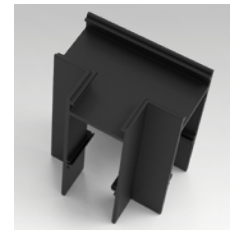
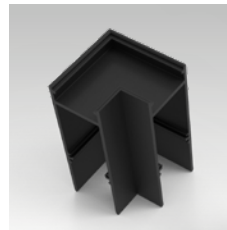

Select your preferred option

Selecione a sua opção preferida
Sélectionnez votre option préférée

| FINISHING | FI |
|--|----|
| <input type="checkbox"/> Textured White | TW |
| <input checked="" type="checkbox"/> Textured Black | TB |
| <input type="checkbox"/> Anodized Aluminium | AL |

4 ACCESSORIES

Acessórios / Accessoires

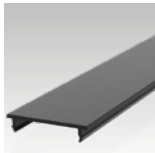

| ACCESSORY | LENGTH | ORDER CODE |
|-------------|---------|------------|
| Blind Cover | 290 mm | 2660290.FI |
| | 570 mm | 2660570.FI |
| | 850 mm | 2660850.FI |
| | 1130 mm | 2661130.FI |

Select your preferred option

Selecione a sua opção preferida
Sélectionnez votre option préférée

| FINISHING | FI |
|--|----|
| <input type="checkbox"/> Textured White | TW |
| <input checked="" type="checkbox"/> Textured Black | TB |

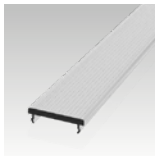

| ACCESSORY | LENGTH | ORDER CODE |
|----------------|---------|------------|
| Diffuser Cover | 850 mm | 2610850.DF |
| | 1130 mm | 2611130.DF |
| | 1410 mm | 2611410.DF |

Select your preferred option

Selecione a sua opção preferida
Sélectionnez votre option préférée

| DIFFUSER | DF |
|---------------|----|
| Opal 90° | O9 |
| Prismatic 80° | P8 |

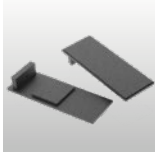

| ACCESSORY | SUSPENDED/SURFACE |
|-----------|-------------------|
| End Cap | 80303022.FI |

Select your preferred option

Selecione a sua opção preferida
Sélectionnez votre option préférée

| FINISHING | FI |
|--|----|
| <input type="checkbox"/> Textured White | TW |
| <input checked="" type="checkbox"/> Textured Black | TB |
| <input type="checkbox"/> Anodized Aluminium | AL |



| ACCESSORY | SUSPENDED/SURFACE |
|--------------|-------------------|
| Linear Joint | 80303023.FI |

Select your preferred option

Selecione a sua opção preferida
Sélectionnez votre option préférée

| FINISHING | FI |
|--|----|
| <input type="checkbox"/> White Coated | WH |
| <input checked="" type="checkbox"/> Black Coated | BL |
| <input type="checkbox"/> Anodized Aluminium | AL |



| ACCESSORY | CABLE | TYPE | ON/OFF |
|-------------|-----------|-------|----------|
| Power Cable | 3x0,75 mm | 1,5 m | 80303001 |
| | | 3 m | 80303002 |
| | | 5 m | 80303003 |
| | 5x0,75 mm | 1,5 m | 80303004 |
| | | 3 m | 80303005 |
| | | 5 m | 80303006 |



| ACCESSORY | CABLE | ORDER CODE |
|----------------|-------|-------------|
| Suspension Kit | 1,5 m | 80303017.SL |
| | 3 m | 80303018.SL |
| | 5 m | 80303019.SL |

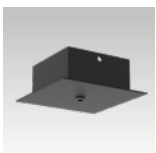

| ACCESSORY | TYPE | DIMENSIONS | RECESSED | SURFACE |
|--------------|--------|------------|-------------|-------------|
| Ceiling Rose | Square | 80x80x16mm | 80303020.FI | --- |
| | Square | 80x80x30mm | --- | 80303021.FI |

Select your preferred option

Selecione a sua opção preferida
Sélectionnez votre option préférée

| FINISHING | FI |
|--|----|
| <input type="checkbox"/> Textured White | TW |
| <input checked="" type="checkbox"/> Textured Black | TB |
| <input type="checkbox"/> Textured Silver | TS |

Communication Interface / Interface de Comunicação / Interface de Communication



| ACCESSORY | DIM CONTROL |
|--------------------------|-------------|
| Casambi DALI Interface * | 8030-2590 |

* Only available with DALI Luminaires / DALI info. on pag. 15

* Disponível apenas com luminárias DALI / DALI info. na pág. 15

* Uniquement disponible avec les luminaires DALI / DALI info. en pag. 15



BRILUMEN
Rua de Oliveira e Sá, nº200
ZI, Maia, Setor 1
4475-263 Maia
PORTUGAL

V.1 2021
ORIS SLIM PRO
PRODUCT CATALOG
CATÁLOGO DE PRODUCTOS
CATALOGUE DE PRODUITS
WWW.BRILUMEN.COM