

# brilumen®

TREV  
LINEAR LED SYSTEMS

## COZINHA



# TREV TRUNKING SYSTEM DIRECT LIGHT

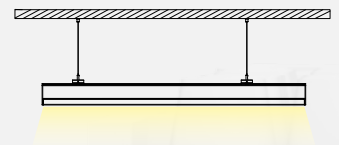
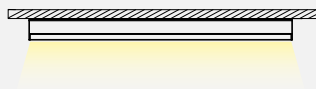
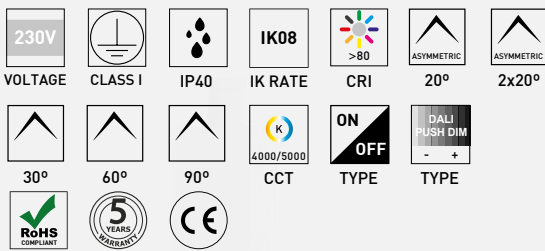
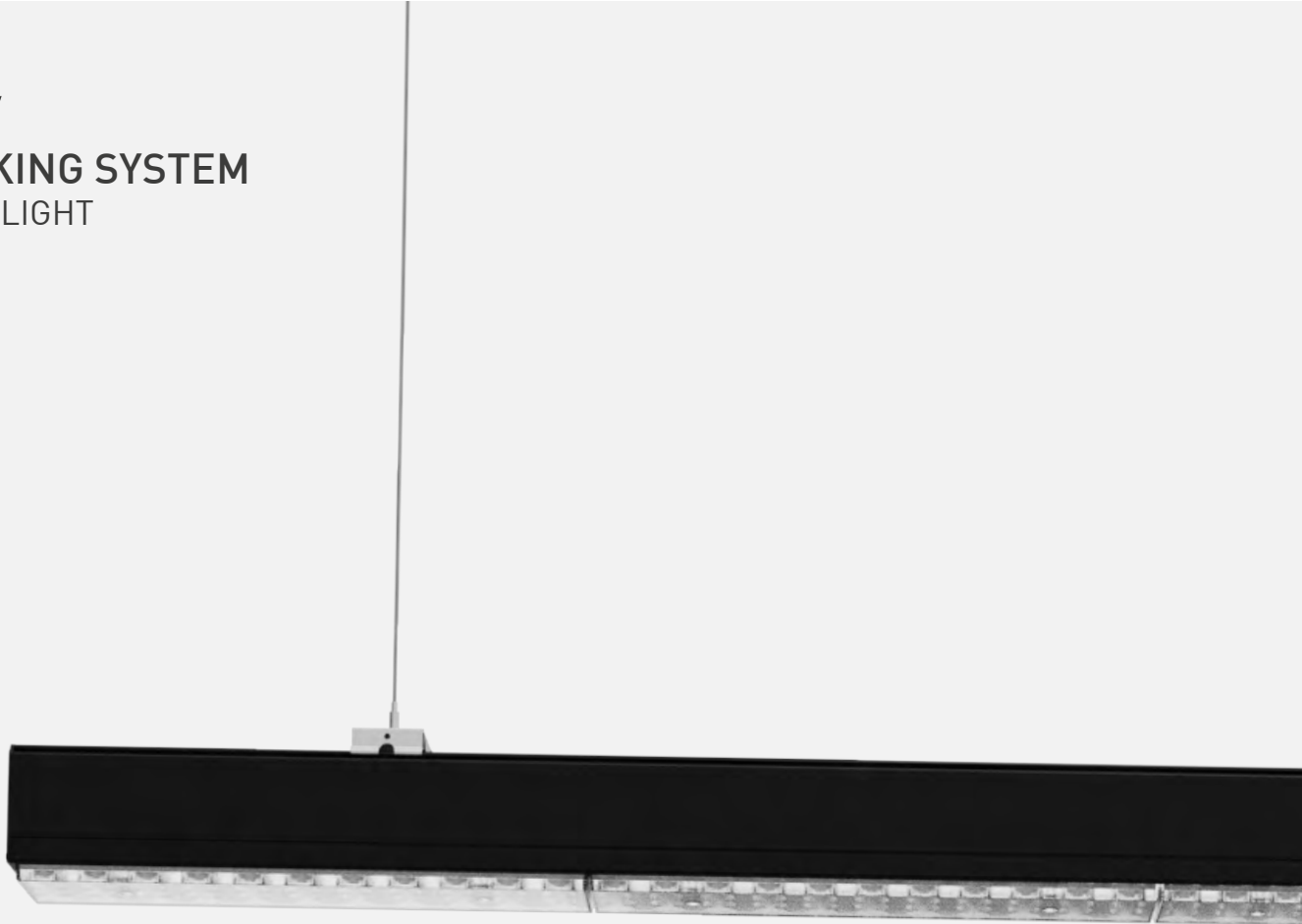

## EN

Brilumen presents TREV, a tailor-made LED lighting solution for large retail stores such as hypermarkets, warehousing and industrial environments, which is characterized by maximum efficiency, a high flexibility and a short return on investment. Thanks to an effective clipping system, TREV is an evolving Trunking light on which you can easily combine Efficiency, High Performance or Blind Cover modules into one main rail according to the local needs, minimizing total cost (low energy consumption, mounting and maintenance costs).

With TREV, it is possible to mount light lines up to 5,17 meters seamless, with an LED efficacy up to 178lm/W, combining a wide variety of beam angle (narrow/ medium/ wide/ asymmetrical/ double asymmetrical) that allows to change the light distribution according to the needs.

The TREV Trunking system made of extruded aluminium has a 5 Year Warranty, is available in suspended or surface mounted version, in ON-OFF or DALI mode, with or without an emergency kit and can be integrated into a Smart

Lighting system.

You can choose between 4000K or 5000K colour temperature and textured white or black and anodized aluminium finishing colours.

TREV is an ideal solution if you are looking for a versatile and quick-mounting Trunking system that fits all the industrial and retail requirements.

PT

A Brilumen apresenta o TREV, uma solução de iluminação LED à medida, para grandes lojas de retalho como hipermercados, área de armazenamento e ambientes industriais, que se caracteriza pela eficiência máxima, alta flexibilidade e rápido retorno do investimento. Graças a um eficaz sistema de molas, o TREV é um sistema evolutivo de iluminação em calha de luz, na qual pode combinar facilmente módulos de iluminação Efficiency, High Performance ou tampa cega, numa calha principal, de acordo com as necessidades do local a iluminar, minimizando o custo total (baixo consumo

de energia, custos de montagem e manutenção).

Com o sistema TREV, é possível montar linhas de luz até 5,17 metros sem uniões, com uma eficácia de LED até 178lm/W, combinando uma ampla variedade de ângulos de feixe (fechado / médio / aberto / assimétrico / duplo assimétrico) que permite alterar a distribuição de luz de acordo com as necessidades. O sistema TREV, em alumínio extrudido, tem uma garantia de 5 anos, está disponível na versão de montagem suspensa ou saliente, no modo ON-OFF ou DALI, com ou sem kit de emergência e pode ser integrado num sistema de

iluminação inteligente. Pode escolher a temperatura de cor 4000K ou 5000K e as cores de acabamento em preto ou branco texturado e alumínio anodizado.

TREV é a solução ideal se estiver à procura de um sistema de iluminação "trunking" versátil e de montagem rápida que responde a todos os requisitos industriais e do retalho.

FR

Brilumen présente TREV, une solution d'éclairage LED sur mesure pour les grandes surfaces commerciales telles que les hypermarchés, les entrepôts et les environnements industriels ; caractérisée par une efficacité maximale, une grande flexibilité et un retour sur investissement à court terme. Grâce à un système de ressorts efficace, TREV est un luminaire évolutif sur lequel il est facile de clipser des modules Efficiency, High Performance ou un cache aveugle en fonction des besoins du local, en minimisant les coûts globaux (faible consommation d'énergie, coûts d'installation et de maintenance réduits).

Avec TREV, il est possible de monter des lignes lumineuses jusqu'à 5,17 mètres sans élément de jonction, avec une efficacité du LED allant jusqu'à 178lm/W, en combinant une grande variété d'angles de faisceau (étroit / moyen / large / asymétrique / double asymétrique) qui permet de changer la répartition de la lumière en fonction des besoins.

Le système de rails TREV en aluminium extrudé bénéficie d'une garantie de 5 ans. Il est disponible en version suspendue ou en saillie, en mode ON-OFF ou DALI, avec ou sans kit d'urgence et peut être intégré dans un système Smart Lighting. Vous

pouvez choisir entre une température de couleur de 4000K ou 5000K et des couleurs de finition en blanc ou noir texturé et en aluminium anodisé. TREV est la solution idéale si vous recherchez un système de rail polyvalent et rapide à monter, qui répond à toutes les exigences des espaces industriels ou de commerce.



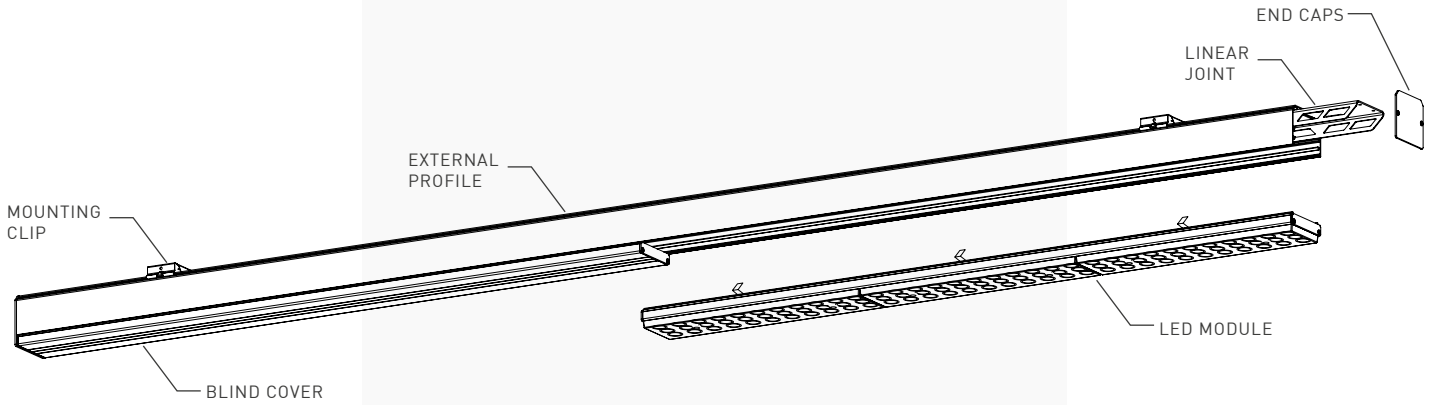















ORDER BUILD

Configurador de encomenda / Configurateur de commande

Choose External Profile  
Escolha o Perfil Externo  
Choisissez le Profil Externe

Choose the LED Module and Optics  
Escolha o Módulo de LED e os Ópticos  
Choisissez le Module LED et Optiques

Choose Accessories  
Escolha os Acessórios  
Choisissez les Accessoires

<p><b>1</b></p> <div style="display: flex; flex-direction: column; gap: 10px;"> <div style="display: flex; align-items: center;">  <div style="margin-left: 10px;"> <p>SUSPENDED SUSPENSO SUSPENDU</p> </div> </div> <div style="display: flex; align-items: center;">  <div style="margin-left: 10px;"> <p>SURFACE SUPERFÍCIE EN SAILLIE</p> </div> </div> </div>	<p><b>2</b></p> <div style="display: flex; flex-direction: column; gap: 10px;"> <div style="display: flex; align-items: center;"> <p><b>2.1</b> Efficiency - CRI80</p> <div style="margin-left: 10px;">  <div style="margin-left: 5px;"> <p>ON/OFF ON/OFF ON/OFF</p> </div> </div> <div style="margin-left: 10px;">  <div style="margin-left: 5px;"> <p>DALI DALI DALI</p> </div> </div> </div> <div style="display: flex; align-items: center;"> <p><b>2.2</b> High Performance - CRI80</p> <div style="margin-left: 10px;">  <div style="margin-left: 5px;"> <p>ON/OFF ON/OFF ON/OFF</p> </div> </div> <div style="margin-left: 10px;">  <div style="margin-left: 5px;"> <p>DALI DALI DALI</p> </div> </div> </div> </div>	<p><b>3</b></p> <div style="display: flex; flex-direction: column; gap: 10px;"> <div style="display: flex; align-items: center;">  <div style="margin-left: 10px;"> <p>WIRING OPTIONS OPÇÕES DE CABLAGEM OPTIONS DE CÂBLAGE</p> </div> <div style="margin-left: 20px;">  <div style="margin-left: 10px;"> <p>END CAPS TOPOS EMBOUTS</p> </div> </div> </div> <div style="display: flex; align-items: center;">  <div style="margin-left: 10px;"> <p>POWER CABLES CABOS DE ALIMENTAÇÃO CÂBLES D'ALIMENTATION</p> </div> <div style="margin-left: 20px;">  <div style="margin-left: 10px;"> <p>EMERGENCY KIT KIT DE EMERGÊNCIA KIT D'URGENCE</p> </div> </div> </div> <div style="display: flex; align-items: center;">  <div style="margin-left: 10px;"> <p>BLIND COVER TAMPA CEGA CACHE AVEUGLE</p> </div> <div style="margin-left: 20px;">  <div style="margin-left: 10px;"> <p>MOUNTING CLIP MOLA DE FIXAÇÃO CLIP DE MONTAGE</p> </div> </div> </div> <div style="display: flex; align-items: center;">  <div style="margin-left: 10px;"> <p>SUSPENSION KITS KITS DE SUSPENSÃO KITS DE SUSPENSION</p> </div> <div style="margin-left: 20px;">  <div style="margin-left: 10px;"> <p>LINEAR JOINT EMENDA LINEAR AMENDEMENT LINÉAIRE</p> </div> </div> </div> </div>
--	--	---



**GENERAL INFO**  
Trunking System  
Suspended / Surface  
Class I  
IP40

**BEAM ANGLE**  
30° / 60° / 90° / 20° Asym / 2x 20° Asym

**LED PCB**  
4000K / 5000K  
CRI>80  
Lifetime 50.000h Tp 55°C  
3 Steps MacAdam

**DIMENSIONS (mm)**

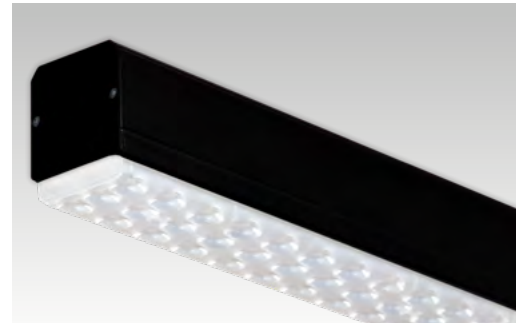
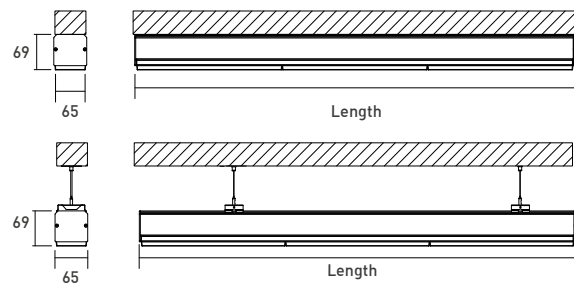

**1 External Profile**  
Perfil Externo / Profil Externe

LENGTH	SUSPENDED/SURFACE
868 mm	3660868.FI
1736 mm	3661736.FI
2604 mm	3662604.FI
3472 mm	3663472.FI

**Select your preferred option**

Selecione a sua opção preferida  
Sélectionnez votre option préférée

FINISHING		FI
<input type="checkbox"/>	Textured White	TW
<input checked="" type="checkbox"/>	Textured Black	TB
<input type="checkbox"/>	Anodized Aluminium	AL

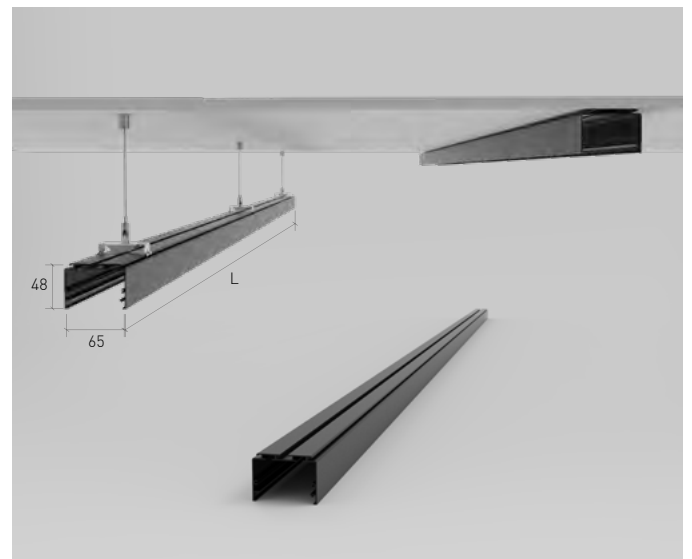

## 2 LED Module and Optics

Módulo de LED e Ópticos / Module LED et Optiques

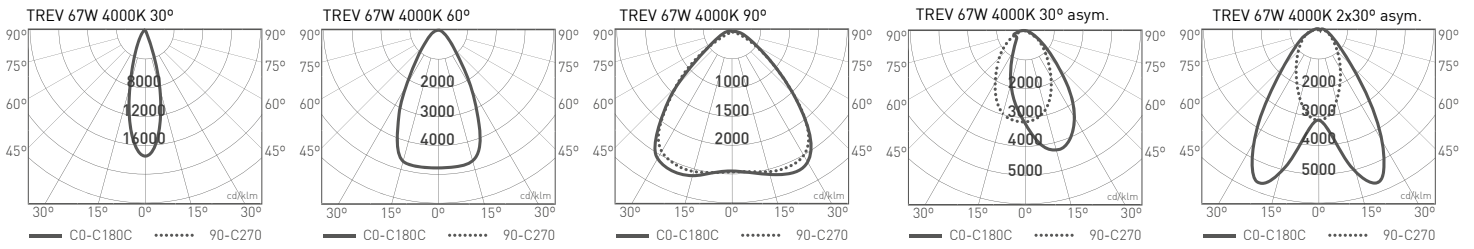

**Note**  
Full photometrics available online. / Fotometrias completas disponíveis online. / Photométries complètes disponibles en ligne.

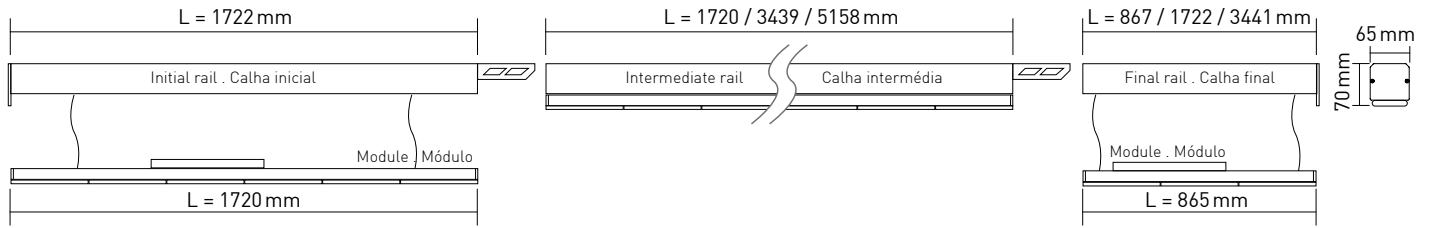

### 2.1 Efficiency - CRI80

**Efficiency Module - CRI>80**  
Product Table / Tabela de produtos / Tableau des produits

CONTROL TYPE	LENGTH	POWER	CCT	LED LUMENS	LUMINAIRE LM	EFFICACY	ORDER CODE
NF, DA	868 mm	22,8 W	4000K	4003 lm	3803 lm	175 lm/W	168XX.08BA.840.FI
			5000K	4062 lm	3859 lm	178 lm/W	168XX.08BA.850.FI
	1732 mm	45,7 W	4000K	8006 lm	7606 lm	175 lm/W	168XX.17BA.840.FI
			5000K	8124 lm	7718 lm	178 lm/W	168XX.17BA.850.FI

\*Lumen details for DAS diffuser / \* Detalhes de lumen para difusor DAS / \* Détails de lumen pour diffuseur DAS

Select your preferred option

Selecione a sua opção preferida  
Sélectionnez votre option préférée

CONTROL TYPE	XX	BEAM ANGLE	BA	FINISHING	FI
ON/OFF	NF	30°	30	<input type="checkbox"/> Textured White	TW
DALI PUSH DIM	DA	60°	60	<input checked="" type="checkbox"/> Textured Black	TB
		90°	90	<input type="checkbox"/> Anodized Aluminium	AL
		20° Asymmetric	AS		
		2x20° Asymmetric	DAS		

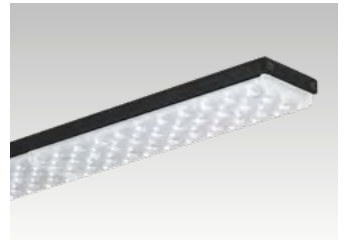

### 2.2 High Performance - CRI80

**High Performance Module - CRI>80**  
Product Table / Tabela de produtos / Tableau des produits

CONTROL TYPE	LENGTH	POWER	CCT	LED LUMENS	LUMINAIRE LM	EFFICACY	ORDER CODE
NF, DA	868 mm	33,3 W	4000K	5273 lm	5009 lm	158 lm/W	169XX.08BA.840.FI
			5000K	5351 lm	5083 lm	161 lm/W	169XX.08BA.850.FI
	1732 mm	66,6 W	4000K	10546 lm	10019 lm	158 lm/W	169XX.17BA.840.FI
			5000K	10701 lm	10166 lm	161 lm/W	169XX.17BA.850.FI

\*Lumen details for DAS diffuser / \* Detalhes de lumen para difusor DAS / \* Détails de lumen pour diffuseur DAS

Select your preferred option

Selecione a sua opção preferida  
Sélectionnez votre option préférée

CONTROL TYPE	XX	BEAM ANGLE	BA	FINISHING	FI
ON/OFF	NF	30°	30	<input type="checkbox"/> Textured White	TW
DALI PUSH DIM	DA	60°	60	<input checked="" type="checkbox"/> Textured Black	TB
		90°	90	<input type="checkbox"/> Anodized Aluminium	AL
		20° Asymmetric	AS		
		2x20° Asymmetric	DAS		

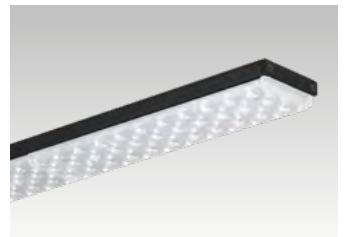

**3** Accessories  
Acessórios / Accessoires

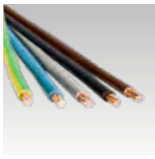

ACCESSORY	RAIL LENGTH	CONTROL	TYPE	1 PHASE	3 PHASE
Wiring Options	868 mm	On/Off	3x2,5mm2	3WT.15.08	
			5x2,5mm2		5WT.15.08
		Dimming	5x2,5mm2	5WT.15.08	
			7x2,5mm2		7WT.15.08
		Emergency	5x2,5mm2	5WT.15.08	
			7x2,5mm2		7WT.15.08
	1736 mm	On/Off	3x2,5mm2	3WT.15.17	
			5x2,5mm2		5WT.15.17
		Dimming	5x2,5mm2	5WT.15.17	
			7x2,5mm2		7WT.15.17
		Emergency	5x2,5mm2	5WT.15.17	
			7x2,5mm2		7WT.15.17
		Dimming + Emergency	7x2,5mm2	7WT.15.17	
			9x2,5mm2		9WT.15.08



ACCESSORY	CABLE	1,5M	3M	5M
Power Cable*	3x2,5mm2	30800245	30800249	30800253
	5x2,5mm2	30800246	30800250	30800254
	7x2,5mm2	30800247	30800251	30800255
	9x2,5mm2	30800248	30800252	30800256



ACCESSORY	CABLE	ORDER CODE
Suspension Kit	1,5 m	80303017.SL
	3 m	80303018.SL
	5 m	80303019.SL

Note: \* The number of wires should match the number chosen from the Wiring Options.  
\* O número de condutores deve ser igual ao número de condutores escolhido na Opção de Cablagem.  
\* Le nombre de fils doit correspondre au nombre choisi pour l'Option de Câblage.



ACCESSORY	ORDER CODE
End Caps	80303061.FI

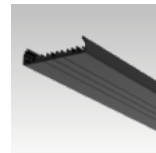

ACCESSORY	LENGTH	ORDER CODE
Blind Cover	868 mm	3680868.FI
	1736 mm	3681736.FI

Select your preferred option

Selecione a sua opção preferida  
Sélectionnez votre option préférée

FINISHING	FI
<input type="checkbox"/> Textured White	TW
<input checked="" type="checkbox"/> Textured Black	TB
<input type="checkbox"/> Anodized Aluminium	AL

Select your preferred option

Selecione a sua opção preferida  
Sélectionnez votre option préférée

FINISHING	FI
<input type="checkbox"/> Textured White	TW
<input checked="" type="checkbox"/> Textured Black	TB
<input type="checkbox"/> Anodized Aluminium	AL



DESCRIPTION	ORDER CODE
Tridonic emergency kit 150W 50-200VDC 1H 4 cells	6080-006
Tridonic emergency kit 150W 50-200VDC 3H 4 cells	6080-007



ACCESSORY	ORDER CODE
Mounting Clip for Trunking System	5004-020
Linear Joint	5004-014

\*More info. on pag. 300 / \* Mais info. na pág. 300 / \*Plus d'info. en pag. 300

Communication Interface / Interface de Comunicação / Interface de Communication



ACCESSORY	DIM CONTROL
Casambi DALI Interface *	8030-2590

\* Only available with DALI Luminaires / DALI info. on pag. 15  
\* Disponível apenas com luminárias DALI / DALI info. na pág. 15  
\* Uniquement disponible avec les luminaires DALI / DALI info. en pag. 15





**brilumen**

BRILUMEN  
Rua de Oliveira e Sá, nº200  
ZI, Maia, Setor 1  
4475-263 Maia  
PORTUGAL

V.1 2021  
TREV - LINEAR LED SYSTEMS  
PRODUCT CATALOG  
CATÁLOGO DE PRODUTOS  
CATALOGUE DE PRODUITS  
WWW.BRILUMEN.COM