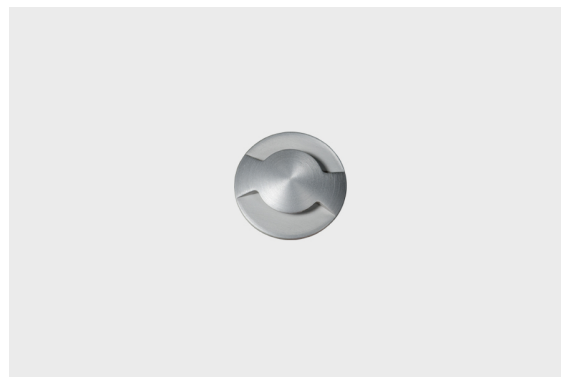

**DESCRIPTION**

The Outdoor Lighting range developed by Brilumen is essentially based on differentiated, high-quality products with high IP ratings, and the floor lighting is no exception. To perfectly conclude the outdoor lighting of your balcony or garden, the inground and decks light choice – Lunen, Orion & Bennet – with IP65, will bring harmony to these places. NOTE: Orion and Bennett have 3 Volts, requiring an external drive to connect the luminaires to 230 Volts, as well as a waterproof box to preserve the products' IP rating.

<b>MOUNTING</b>	Surface
<b>LIGHT DISTRIBUTION</b>	Directa
<b>POWER SUPPLY</b>	230V / 50/60 Hz
<b>WARRANTY</b>	2 Years
<b>FINISHING</b>	Brushed Aluminum
<b>CONTROL</b>	ON/OFF

**LED FEATURES**

<b>LUMINOUS EFFICIENCY</b>	UP TO 92 lm/W
<b>CRI</b>	CRI>85
<b>LIFESPAN</b>	50.000 Hours
<b>STEPS MACADAM</b>	4 Steps MacAdam
<b>LUMEN MAINTENANCE</b>	L90/B50
<b>PHOTOBIOLOGICAL RISK</b>	RG0

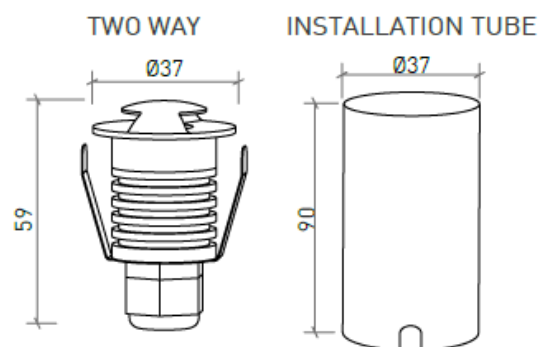
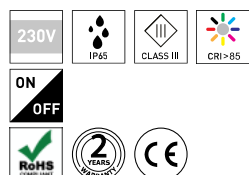
**TECHNICAL DRAWING**

**ICONOGRAPHY**

**BENNET TWO WAYS 1W**  
**PRODUCT TABLE AND TECHNICAL SPECIFICATIONS - CRI>85**





LENGTH	POWER	FINISHING	CONTROLTYPE	BEAM ANGLE	LED LUMENS	LUMINAIRE LM	COLOR TEMP.	CODE
37	1	BAL	NF	70°H/10°V	92	44	3000K	601.85.70.30.FI
37	1	BAL	NF	70°H/10°V	101	49	4000K	601.85.70.40.FI

**SELECT YOUR PREFERRED OPTION**

<b>CONTROLTYPE</b>	<b>XX</b>
ON/OFF	NF

<b>FINISHING</b>	<b>FI</b>
Brushed Aluminum	BAL

**ACCESSORIES**

	Waterproof box Waterproof box	-	4080-1030
	Output cable gland Output cable gland	-	4080-1031
	Cover for waterproof box Cover for waterproof box	-	4080-1033
	Driver (3-5 luminaires) Driver (3-5 luminaires)	-	8015-0224
	Driver (1-3 luminaires) Driver (1-3 luminaires)	-	8015-0226

