

DESCRIPTION

The Outdoor Lighting range developed by Brilumen is essentially based on differentiated, high-quality products with high IP ratings, and the floor lighting is no exception. To perfectly conclude the outdoor lighting of your balcony or garden, the inground and decks light choice – Lunen, Orion & Bennet – with IP67, will bring harmony to these places. NOTE: Orion and Bennett have 3 Volts, requiring an external drive to connect the luminaires to 230 Volts, as well as a waterproof box to preserve the products' IP rating.

MOUNTING TYPE	Recessed
LIGHT DISTRIBUTION	Direct
POWER SUPPLY	230 VAC / 50/60 Hz
WARRANTY	2 Years
FINISHING	Brushed steel
CONTROL	ON/OFF

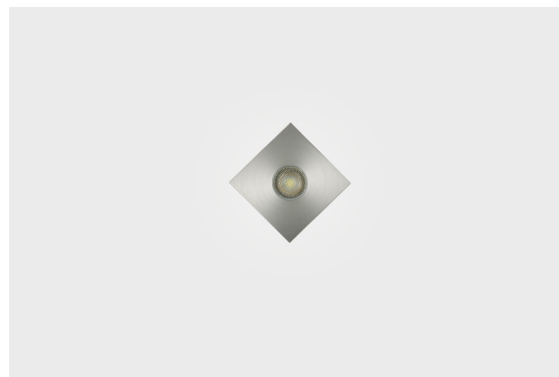

LED FEATURES

LUMINOUS EFFICIENCY	UP TO 87 lm/W
CRI	CRI->85
LIFESPAN	50.000 Hours
STEPS MACADAM	4 Steps MacAdam

TECHNICAL DRAWING

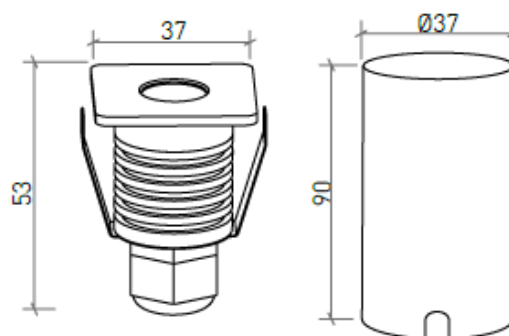

ICONOGRAPHY

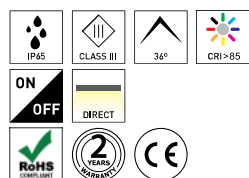

 ORION SQUARE 2W
PRODUCT TABLE AND TECHNICAL SPECIFICATIONS - CRI->85

LENGTH	POWER	FINISHING	CONTROL TYPE	BEAM ANGLE	LED LUMENS	LUMINAIRE LM	COLOR TEMP.	CODE
37	2	BS	NF	36	180	158	3000K	602.85.BA.30.FI
37	2	BS	NF	36	198	174	4000K	602.85.BA.40.FI

SELECT YOUR PREFERRED OPTION

CONTROL TYPE	XX	FINISHING	FI	BEAM ANGLE	BA
ON/OFF	NF	Brushed steel	BS	36°	36

ACCESSORIES

 Waterproof box
Waterproof box
SEM TITULO - 4080-1030

 Output cable gland
Output cable gland
SEM TITULO - 4080-1031

 Cover for waterproof box
Cover for waterproof box
SEM TITULO - 4080-1033

 Driver 700mA - 1 un
Driver 700mA - 1 un
SEM TITULO - 8015-0227

Driver 700mA - 2 a 5 un
Driver 700mA - 2 a 5 un
SEM TITULO - 8015-0228

