

DESCRIPTION

Horizontal curve radius 0,5m for MT1 48V MICRO track

ICONOGRAPHY



TECHNICAL DRAWING

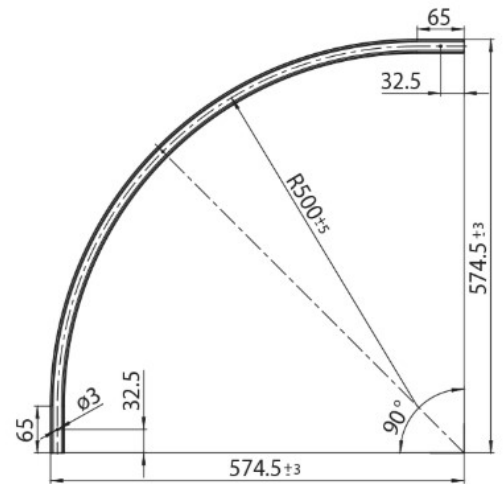

ACCESSORIES



Horizontal curve 0,5m MT1
 Horizontal curve 0,5m

White	Black
3080-0603.WH	3080-0603.BL