

DESCRIPTION

The LP10 LED SURFACE Profile has a narrow and flat design and is designed as a universal cable duct for LP - NP - OP series aluminium profiles. The LP10 LED SURFACE Profile is connected via a click in system to stand-alone linear LED lighting systems.



ICONOGRAPHY



TECHNICAL DRAWING

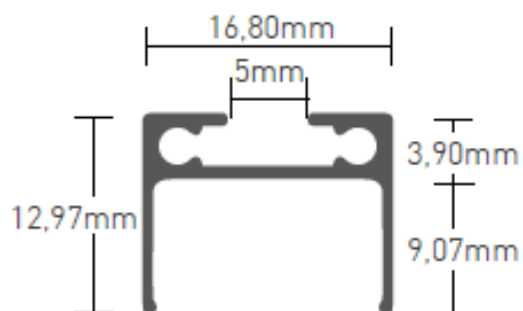

LP10 ALUMINIUM PROFILE

PRODUCT TABLE AND TECHNICAL SPECIFICATIONS - LP10 anodised aluminium profile - 2000mm x 16,8mm x 12,97mm

ACCESSORIES

	Z02 - Mounting Clip Z02 - Mounting Clip	- G810-4050
	LP05 aluminium profile LP05 aluminium profile	SEM TITULO - G810-5201
	LP03 Recessed Profile LP03 Recessed Profile	SEM TITULO - G810-6032
	LP08 Recessed Profile LP08 Recessed Profile	SEM TITULO - G810-6082
	Z01 - Mounting Clip Z01 - Mounting Clip	- G810-6210
	NP04 aluminium profile NP04 aluminium profile	SEM TITULO - G820-1012
	NP06 aluminium profile NP06 aluminium profile	SEM TITULO - G830-1017



**NP07 Recessed Profile
NP07 Recessed Profile**

**SEM TITULO -
G830-5015**



**NP17 aluminium profile
NP17 aluminium profile**

**SEM TITULO -
G810-2026**



**LP06 aluminium profile
LP06 aluminium profile**

**SEM TITULO -
G810-6062**